



# F-LXP

## Cordless Finish Stapler

**FUSION™**  
TECHNOLOGY



**IMPORTANT:** Read operating instructions before use.

**Operating Instructions**

(Original Instructions)

**Betriebsanleitung**

(Übersetzung der Ursprünglichen Anweisungen)

**Mode d'Emploi**

(Traduction des Instructions Originales)

**Gebruiksaanwijzing**

(Vertaling van de Oorspronkelijke Gebruiksaanwijzing)

**Instrucciones de Empleo**

(La Traducción de las Instrucciones Originales)

**Istruzioni per l'Uso**

(Traduzione delle Istruzioni Originali)

**Οδηγίες Χρήσεως**

(μετάφραση των αρχικών οδηγιών)

**Brukvisning**

(Översättning av de Ursprungliga Undervisningarna)

**Brukvisning**

(Oversættelse av de Originale Instruksjonene)

**Käyttöohjeet**

(Alkuperäisten Ohjeiden Käännös)

**Bruksanvisning**

(Oversættelse af de Originale Instruktioner)

**Инструкция по эксплуатации**

(Перевод оригинальной инструкции)

**Instrukcja Obsługi**

(Tłumaczenie oryginalnej instrukcji)

**Kullanma Talimatları**

(Orijinal talimatların çevirisi)

**Kasutusjuhend**

(Algse juhendi tõlge)

**Instruções de Operação**

(Tradução das instruções originais)

**Instruțiuni de utilizare**

(Traducerea instrucțiunii originale)

**Navodila za Uporabo**

(Prevod izvirnega navodila)

**Návod na Používanie**

(Preklad pôvodného pokynu)

**Lietošanas instrukcijas**

(Orijinālā norādījuma tulkojums)

**Használati Utasítások**

(Az eredeti utasítás fordítása)

**Operativní Instrukce**

(Překlad původního pokynu)

**Naudojimo instrukcijos**

(Originalios instrukcijos vertimas)

**Инструкции за експлоатация**

(Превод на оригиналната инструкция)



Kyocera Senco Europe  
Pascallaan 88  
8218 NJ Lelystad, The Netherlands  
+31 320 295 575  
www.senco.eu

NFE2FT3082021



© 2021 by Kyocera Senco Europe

# Table of Contents









<b>Symbols</b> .....	4
<b>General Description</b> .....	5
<b>General Power Tool Safety Warnings</b> .....	5
Work Area Safety .....	5
Electrical Safety .....	5
Personal Safety .....	5
Power Tool Use and Care .....	5
Battery Tool Use and Care .....	6
Service .....	6
<b>Safety Warnings</b> .....	6
<b>Additional Safety Warnings</b> .....	7
<b>Tool Use</b> .....	8
<b>Battery Use</b> .....	8
<b>Functional Operation (F-LXP)</b> .....	10
<b>Tool Operation</b> .....	11
<b>Battery Charger Label Reference</b> .....	14
Charger Symbols .....	15
Battery Disposal .....	15
Battery Transport .....	15
<b>Maintenance</b> .....	15
<b>Accessories</b> .....	15
<b>Fastener Specifications</b> .....	16
<b>Technical Specifications</b> .....	16
<b>Noise/Vibration Information</b> .....	16
<b>Troubleshooting</b> .....	17

## SYMBOLS

The following signal words and meanings are intended to explain the levels of risk associated with this product.

SYMBOL	SIGNAL	MEANING
	<b>DANGER:</b>	Indicates a hazardous situation, which, if not avoided, will result in death or serious injury.
	<b>WARNING:</b>	Indicates a hazardous situation, which, if not avoided, could result in death or serious injury.
	<b>CAUTION:</b>	Indicates a hazardous situation, which, if not avoided, may result in minor or moderate injury.
	<b>NOTICE:</b>	(Without Safety Alert Symbol) indicates information considered important, but not related to a potential injury (e.g. messages relating to property damage).

Some of the following symbols may be used on this product. Please study them and learn their meaning. Proper interpretation of these symbols will allow you to operate the product in a better, safer manner.

SYMBOL	NAME	DESIGNATION/EXPLANATION
	<b>Safety Alert</b>	Indicates a potential personal injury hazard.
	<b>Read Operator's Manual</b>	To reduce the risk of injury, user must read and understand operator's manual before using this product.
	<b>Eye Protection</b>	Always wear eye protection with side shields marked to comply with EN 166.
		Do not rest your finger on the trigger when picking up the tool, moving between operating areas and positions or walking, as resting finger on trigger can lead to inadvertent operation. For tools with selective actuation, always check the tool before use to ascertain the correct mode is selected.  This tool has either selective actuation for contact actuation or continuous contact actuation by actuation mode selectors or is a contact actuation or continuous actuation contact tool and has been marked with the symbol above.  If using this tool in selective actuation mode, always ensure it is in the correct actuation setting.  Be careful when changing from one driving location to another.
	<b>Do Not Oil</b>	Routine lubrication is not necessary.
	<b>Wet Conditions Alert</b>	Do not expose to rain or use in damp locations.
	<b>Recycle</b>	This product uses Lithium-ion batteries. Local, state, or federal laws may prohibit disposal of batteries in ordinary trash. Consult your local waste authority for information regarding available recycling and or disposal options.
<b>V</b>	<b>Volts</b>	Voltage
	<b>Direct Current</b>	Type or characteristic of current



## General Description

Hand held power fastener driving tool consisting of a pneumatic power unit, guide body and magazine in which energy is applied in a linear movement to a loaded fastener for the purpose of driving the fastener into defined materials.

## General Power Tool Safety Warnings

**⚠ WARNING** Read all safety warnings, instructions, illustrations and specifications provided with this power tool. Failure to follow all instructions listed below may result in electric shock, fire and/or serious injury.  
**Save all warnings and instructions for future reference.** The term “power tool” in the warnings refers to your mains-operated (corded) power tool or battery-operated (cordless) power tool.

### WORK AREA SAFETY

1. **Keep work area clean and well lit.** Cluttered or dark areas invite accidents.
2. **Do not operate power tools in explosive atmospheres, such as in the presence of flammable liquids, gases or dust.** Power tools create sparks which may ignite the dust or fumes.
3. **Keep children and bystanders away while operating a power tool.** Distractions can cause you to lose control.

### ELECTRICAL SAFETY

4. **Power tool plugs must match the outlet. Never modify the plug in any way. Do not use any adapter plugs with earthed (grounded) power tools.** Unmodified plugs and matching outlets will reduce risk of electric shock.
5. **Avoid body contact with earthed or grounded surfaces, such as pipes, radiators, ranges and refrigerators.** There is an increased risk of electric shock if your body is earthed or grounded.
6. **Do not expose power tools to rain or wet conditions.** Water entering a power tool will increase the risk of electric shock.
7. **Do not abuse the cord. Never use the cord for carrying, pulling or unplugging the power tool. Keep cord away from heat, oil, sharp edges or moving parts.** Damaged or entangled cords increase the risk of electric shock.
8. **When operating a power tool outdoors, use an extension cord suitable for outdoor use.** Use of a cord suitable for outdoor use reduces the risk of electric shock.
9. **If operating a power tool in a damp location is unavoidable, use a residual current device (RCD) protected supply.** Use of an RCD reduces the risk of electric shock.

### PERSONAL SAFETY

10. **Stay alert, watch what you are doing and use common sense when operating a power tool. Do not use a power tool while you are tired or under the influence of drugs, alcohol or medication.** A moment of inattention while operating power tools may result in serious personal injury.
11. **Use personal protective equipment. Always wear eye protection.** Protective equipment such as dust mask, non-skid safety shoes, hard hat, or hearing protection used for appropriate conditions will reduce personal injuries.
12. **Prevent unintentional starting. Ensure the switch is in the off-position before connecting to power source and/or battery pack, picking up or carrying the tool.** Carrying power tools with your finger on the switch or energizing power tools that have the switch on invites accidents.
13. **Remove any adjusting key or wrench before turning the power tool on.** A wrench or a key left attached to a rotating part of the power tool may result in personal injury.
14. **Do not overreach. Keep proper footing and balance at all times.** This enables better control of the power tool in unexpected situations.
15. **Dress properly. Do not wear loose clothing or jewelry. Keep your hair, clothing and gloves away from moving parts.** Loose clothes, jewelry or long hair can be caught in moving parts.
16. **If devices are provided for the connection of dust extraction and collection facilities, ensure these are connected and properly used.** Use of dust collection can reduce dust-related hazards.
17. **Do not let familiarity gained from frequent use of tools allow you to become complacent and ignore tool safety principles.** A careless action can cause severe injury within a fraction of a second.

### POWER TOOL USE AND CARE

18. **Do not force the power tool. Use the correct power tool for your application.** The correct power tool will do the job better and safer at the rate for which it was designed.
19. **Do not use the power tool if the switch does not turn it on and off.** Any power tool that cannot be controlled with the switch is dangerous and must be repaired.
20. **Disconnect the plug from the power source and/or remove the battery pack, if detachable, from the power tool before making any adjustments, changing accessories, or storing power tools.** Such preventive safety measures reduce the risk of starting the power tool accidentally.
21. **Store idle power tools out of the reach of children and do not allow persons unfamiliar with the power tool or these instructions to operate the power tool.** Power tools are dangerous in the hands of untrained users.
22. **Maintain power tools and accessories. Check for misalignment or binding of moving parts, breakage of parts and any other condition that may affect the power tool's operation. If damaged, have the power tool repaired before use.** Many accidents are caused by poorly maintained power tools.

23. **Keep cutting tools sharp and clean.** Properly maintained cutting tools with sharp cutting edges are less likely to bind and are easier to control.
24. **Use the power tool, accessories and tool bits etc. in accordance with these instructions, taking into account the working conditions and the work to be performed.** Use of the power tool for operations different from those intended could result in a hazardous situation.
25. **Keep handles and grasping surfaces dry, clean and free from oil and grease.** Slippery handles and grasping surfaces do not allow for safe handling and control of the tool in unexpected situations.

## BATTERY TOOL USE AND CARE

26. **Recharge only with the charger specified by the manufacturer.** A charger that is suitable for one type of battery pack may create a risk of fire when used with another battery pack.
27. **Use power tools only with specifically designated battery packs.** Use of any other battery packs may create a risk of injury and fire.
28. **When battery pack is not in use, keep it away from other metal objects, like paper clips, coins, keys, nails, screws or other small metal objects, that can make a connection from one terminal to another.** Shorting the battery terminals together may cause burns or a fire.
29. **Under abusive conditions, liquid may be ejected from the battery; avoid contact. If contact accidentally occurs, flush with water. If liquid contacts eyes, additionally seek medical help.** Liquid ejected from the battery may cause irritation or burns.
30. **Do not use a battery pack or tool that is damaged or modified.** Damaged or modified batteries may exhibit unpredictable behaviour resulting in fire, explosion or risk of injury.
31. **Do not expose a battery pack or tool to fire or excessive temperature.** Exposure to fire or temperature above 130 °C may cause explosion.
32. **Follow all charging instructions and do not charge the battery pack or tool outside the temperature range specified in the instructions.** Charging improperly or at temperatures outside the specified range may damage the battery and increase the risk of fire.

## SERVICE

33. **Have your power tool serviced by a qualified repair person using only identical replacement parts.** This will ensure that the safety of the power tool is maintained.
34. **Never service damaged battery packs.** Service of battery packs should only be performed by the manufacturer or authorized service providers.

## Safety Warnings

1. **Always assume the tool contains fasteners.** Careless handling of the nailer can result in unexpected firing of fasteners and personal injury.
2. **Do not point the tool towards yourself or anyone nearby.** Unexpected triggering will discharge the fastener causing an injury.
3. **Do not actuate the tool unless the tool is placed firmly against the workpiece.** If the tool is not in contact with the workpiece, the fastener may be deflected away from your target.
4. **Disconnect the tool from the power source when the fastener jams in the tool.** While removing a jammed fastener, the nailer may be accidentally activated if it is energized.
5. **Use caution while removing a jammed fastener.** The mechanism may be under compression and the fastener may be forcefully discharged while attempting to free a jammed condition.
6. **Do not use this nailer for fastening electrical cables.** It is not designed for electric cable installation and may damage the insulation of electric cables thereby causing electric shock or fire hazards.
7. **Wear ear protectors.** Exposure to noise can cause hearing loss.
8. **Hold the power tool by insulated gripping surfaces, when performing an operation where the fastener may contact hidden wiring.** Fasteners contacting a "live" wire may make exposed metal parts of the power tool "live" and could give the operator an electric shock.
9. **Do not use the power tool in locations where the ambient temperature may reach 4°C (39.2°F) or exceed 40°C (105°F).**
10. **A battery short can cause a large current flow, overheating, possible burns and even a breakdown.**
  - Do not touch the terminals with any conductive material.
  - Avoid storing battery cartridge in a container with other metal objects such as nails, coins, etc.
  - Do not expose battery cartridge to water or rain.
11. **Consecutive charging may cause overheating.** If you need to recharge batteries consecutively, wait about 15 minutes for the charger to cool.

## Additional Safety Warnings



To prevent eye injuries, always wear EN166 safety glasses with permanently attached rigid, hard plastic side shields. Be sure everyone in your work area is wearing the same type of safety glasses.



### DANGER

The Fusion tool is charged with compressed air in a sealed chamber. Prior to any service or repair, release the charge of pressurized gas.

The pressurized air must be released prior to service. Major components such as the piston/driver assembly, gearbox, piston stop and guide body are all part of the drive assembly.

Deliberate tampering with the drive assembly may result in the release of the driver.

Any repair or upgrade requiring access to the pressure chamber may be handled by an authorized Senco dealer or service center.

#### Disconnect tool from battery when:

- Outside of the operator's supervision or control.
- Performing maintenance or repair
- Clearing a jam
- Moving the tool to a new location
- Adjusting depth of drive

With battery disconnected, make daily inspection to assure free movement of workpiece contact element and trigger. Do not use tool if workpiece contact element or trigger sticks or binds.

Always remove finger from trigger when not driving fasteners. Never carry the tool with finger on or under trigger. Tool will eject a fastener if the workpiece contact element is bumped and the trigger is pulled.

Drive fasteners into work surface only; never into materials too hard to penetrate.

Do not drive fasteners on top of other fasteners or with the tool at too steep of an angle; the fasteners can ricochet and hurt someone.

When using tool, care should be taken due to possibility of tool recoil after a fastener is driven. If workpiece contact element is unintentionally allowed to re-contact work surface following a recoil, an unwanted fastener may be driven. Therefore, allow tool to recoil completely off work surface after a fastener is driven to avoid this condition. Do not push workpiece contact element on work surface until a second fastener is desired.

#### Please review triggering options.

Do not drive fasteners close to the edge of the work surface. The workpiece is likely to split and the fastener could fly or ricochet and hit someone.

Never use any part of the tool (i.e., the cap or mainbody) as a hammer. The tool may activate or become damaged and result in an unsafe condition.



Keep hands and other body parts away from the area shown in the circle to avoid possible injury during operation.



Do not use tool without Danger Label on tool. If label is missing, damaged or unreadable, contact your SENCO representative to obtain a new label at no cost.

## **WARNING** Tool Use



Read and understand tool labels and manual. Failure to follow warnings will result in DEATH or SERIOUS INJURY.



Operators and others in work area **MUST** wear safety glasses with side shields.



Keep fingers **AWAY** from trigger when not driving fasteners, to avoid accidental firing.

Choice of triggering method is important. See page 11 for triggering options.

Never point tool at yourself or others in work area.



Always point the tool away when connecting battery.



Do not alter or remove trigger or safety.

Tools shall not be modified without written approval of the manufacturer.

Use clamps or other practical ways to secure and support the workpiece to a stable platform. Holding the work by hand or against your body is unstable and may lead to loss of control.

## Battery Use



### CHARGER

VB0157	EU
VB0158	AU
VB0159	UK

### ADDITIONAL SAFETY RULES FOR CHARGER & BATTERY CARTRIDGE

#### SAVE THESE INSTRUCTIONS

This manual contains important safety and operating instructions for SENCO battery chargers.

Before using a SENCO battery charger, read all instructions and cautionary markings on battery charger and battery.



Battery	VB0213
Rated Capacity	2.0Ahr
Chemistry	Li-Ion
Number of Cells	5
Voltage	18V

Do not expose charger to water, rain, or snow.  
Use indoors.

Use of an attachment not recommended or sold by the battery charger manufacturer may result in a risk of fire, electric shock, or injury to persons.

To reduce risk of damage to electric plug and cord, pull by plug rather than cord when disconnecting charger.

Make sure cord is located so that it will not be stepped on, tripped over, or otherwise subjected to damage or stress.

Length of Cord (meters)			
7.5	15	30	45
16	16	16	14
AWG Size of Cord			

## RECOMMENDED MINIMUM AWG SIZE FOR EXTENSION CORDS FOR BATTERY CHARGERS

An extension cord should not be used unless absolutely necessary. Use of improper extension cord could result in a risk of fire and electric shock.

If extension cord must be used, make sure:

- That pins on plug of extension cord are the same number, size, and shape as those of plug on charger;
- That extension cord is properly wired and in good electrical condition; and
- That wire size is at least as large as the one specified in the table.

Do not operate charger with damaged cord or plug. If damaged, have replaced immediately by a qualified serviceman.

Do not operate charger if it has received a sharp blow, been dropped, or otherwise damaged in any way; take it to a SENCO Authorized Service Center.

Do not disassemble charger or battery cartridge; take it to a SENCO Authorized Service Center when service or repair is required. Incorrect reassembly may result in a risk of electric shock or fire.

To reduce risk of electric shock, unplug charger from outlet before attempting any maintenance or cleaning.



Do not charge battery cartridge when temperature is BELOW 0°C (32°F) or ABOVE 40°C (104°F).

Do not attempt to use a step-up transformer, an engine generator or DC power receptacle.

Do not recharge non-rechargeable batteries.

Do not allow anything to cover or clog the charger vents.

Do not store the tool and battery cartridge in locations where the temperature may reach or exceed 45°C (113°F).

Store battery packs 30-50% charged condition.

Charge battery pack every 6 months.

Do not incinerate the battery cartridge even if it is severely damaged or is completely worn out. The battery cartridge can explode in a fire.

Never attempt to connect two (2) chargers together.

## WARNING:

To reduce the risk of fire, personal injury and product damage due to a short circuit, never immerse your tool, battery pack or charger in fluid or allow a fluid to flow inside them.

Corrosive or conductive fluids, such as seawater, certain industrial chemicals and bleach or bleach containing products, etc., can cause a short circuit.

This appliance is not intended for use by young children or infirm persons unless they have been adequately supervised by a responsible person to ensure that they do not play with the appliance.

This appliance is not intended for use by persons (including children) with reduced physical, sensory or mental capabilities, or lack of experience and knowledge, unless they have been given supervision or instruction concerning use of the appliance by a person responsible for their safety. Children should be supervised to ensure that they do not play with the appliance.

For more information, safety training, materials and programs, visit the website at [www.senco.eu](http://www.senco.eu)

# Functional Operation (F-LXP)

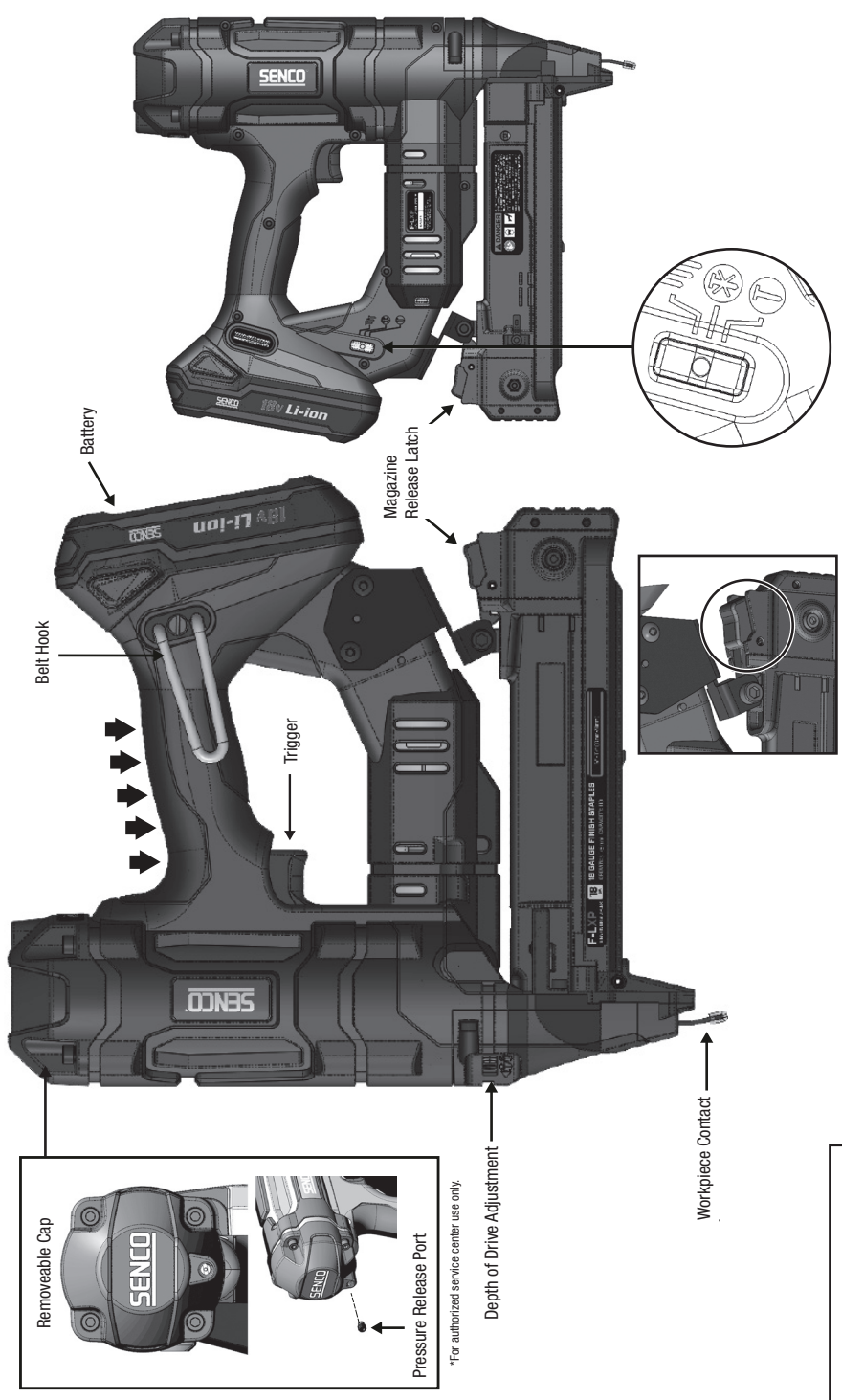

\*For authorized service center use only.



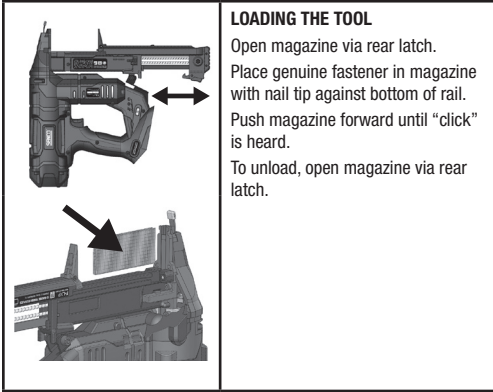

**LOADING THE TOOL**  
 Open magazine via rear latch.  
 Place genuine fastener in magazine with nail tip against bottom of rail.  
 Push magazine forward until "click" is heard.  
 To unload, open magazine via rear latch.

## Tool Operation

Read section titled "Safety Warnings," before using tool.	
For best results, charge new battery before using. (see "To Charge Battery" on page 14).	
<p><b>Indicator LED ON</b></p>	<p>The tool should be switched off when not in use. Hold down either side of the selector switch for 1 second to turn the tool off. If left on, the tool will automatically turn off after 34 minutes.</p>
All Fusion tools are equipped with selective-actuation triggering. This allows the user to choose between the following modes of operation:	

<p><b>Indicator LED ON-Flashing</b></p>	<p><b>Contact Actuation</b>                  Pressing the side of the selector switch toward the TTT symbol (as shown) for 0.5 sec. will turn the tool on in contact-actuation mode. This is indicated by the flashing green LED of the selector switch.</p>
---	--

<p><b>Indicator LED ON-Solid</b></p>	<p><b>Sequential</b>                  Pressing the side of the selector switch toward the T symbol (as shown) for 0.5 sec. will turn the tool on in sequential mode. This is indicated by the solid green LED of the selector switch.</p>
--------------------------------------	---

In the "contact-actuation" mode, nails can be driven in two ways:

<p><b>A</b></p>	<p><b>The first way:</b></p> <ol style="list-style-type: none"> <li>1. Press the TTT side of the selector switch for 0.5 seconds. This will be indicated by the flashing green LED on the selector switch.</li> <li>2. Press the workpiece contact (safety) element against the work surface.</li> <li>3. Pull the trigger and the fastener is driven.</li> </ol>
-----------------	---

<p><b>B</b></p>	<p><b>The Second way:</b></p> <ol style="list-style-type: none"> <li>1. Press the TTT side of the selector switch for 0.5 seconds. This will be indicated by the flashing green LED on the selector switch.</li> <li>2. Pull trigger.</li> <li>3. Depress workpiece contact element against work surface and drive a fastener.</li> </ol> <p>This mode of operation is preferred when you desire high production, rapid fastener placement.</p>
-----------------	---

In the "sequential-actuation" mode, nails can only be driven one way:

	<ol style="list-style-type: none"> <li>1. Press the T side of the selector switch for 0.5 seconds. This will be indicated by the solid green LED on the selector switch.</li> <li>2. Position workpiece contact (safety) element against work surface and depress the safety.</li> <li>3. Pull trigger to turn on the motor and drive a single fastener.</li> </ol> <p>This mode of operation is helpful when you require precise fastener placement.</p>
--	---

	<p>The Fusion nailer may detect a jam. The warning indicator on the selector switch will flash red.</p>
--	---



This tool is equipped with an indicator light at the ON/OFF/MODE switch. See page 11 for detailed instructions.

**Note:**

When the tool is in the sequential mode, a fastener cannot be driven by pulling the trigger before activating the work piece contact element.

If the workpiece contact is activated for more than 10 seconds, the workpiece contact must be released to start over.

When the tool is in contact actuation mode, if the operator holds the trigger on for more than 3 seconds, the light will go out and the trigger must be released to start over.

Do not select contact actuation mode when working on scaffolds, ladders or platforms where you may need to move your body position. Select sequential to reduce potential for injury to yourself or others.

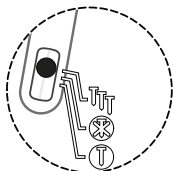

This tool is equipped with a multi-purpose light in the mode switch. The mode sensor light will indicate that the electronic controls are energized, which operating mode has been selected, if a jam was detected and when the battery requires a full recharge.

**Solid or Flashing Green Light**

Indicates the tool is energized and ready to drive.

If light does not turn on, look to be sure that the trigger or work contact element are free to move and not in the activated position.

**Solid Red Light**

Indicates the tool has detected an error.

Low battery. The battery will usually detect the condition first and turn the tool off. Recharge the battery or replace with a freshly charged battery to continue. If the tool has detected this condition first, it is usually due to sustained extreme use. Replace the battery with a fully charged battery.

The tool detected a timing issue. This can be caused by low charge pressure, an application requiring drive energy above the tools capacity, a loose battery connection or broken components. Re-insert the battery or replace the battery with a freshly charged battery. If this does not remedy the issue, refer to the troubleshooting guide or contact an authorized service center.

**Flashing Red Light**

Indicates a fastener jam.

The tool detects a jam which is usually due to a deformed nail wedged in the driver path.

Remove the battery from tool, re-insert battery and turn on tool. If tool does not return to normal operation, go to next step.

**REMOVE the BATTERY**

Unload all remaining fasteners in magazine. Make sure that any loose fastener from strip is also removed.

Carefully remove the jammed fastener.

Reassemble the magazine.

Attach charged battery to tool.

Load nails into magazine.

Resume normal operation.



If the wedged fastener can't be removed, return to an authorized service center where the damaged fastener can be removed. Remember that the Fusion tool contains pressurized air at all times even when the battery is removed.

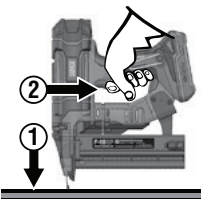
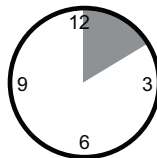

This tool is equipped with an electronic "Time-Out" feature. This tool will temporarily be disabled under any of the following conditions:

1. Workpiece contact element is depressed against the work piece, but the trigger is not pressed within approximately 10 seconds.
2. Trigger is pressed, but work piece contact element is not depressed within approximately 3 seconds. (Contact-Actuation mode only.)
  - Simply release trigger and release workpiece contact element to resume normal operation.



The tool is equipped with a last fastener lockout. The tool will not fire the last 4-7 fasteners in the F-LXP. This feature prevents unnecessary wear on the tool and prevents the driver tip from marring the workpiece. When the tool locks out, load an additional strip and continue. It is not necessary to remove the remaining fasteners from the magazine.

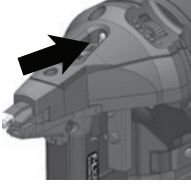

This tool is equipped with a dual-purpose light on the nosepiece. The light will indicate that the electronic controls are energized while providing illumination of the workpiece in low light situations. The light will flash three times when the selector switch is switched to either sequential or contact actuation. This lets the user know that the tool is ready to fire a fastener. The light will remain on for ten seconds when the trigger is pulled or the work contact element is depressed.

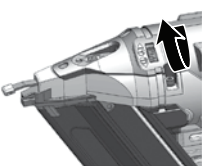

This tool is equipped with depth-of-drive dial. Turning the dial to the right will countersink the fastener, turning the dial to the left will leave the fastener up or raised. Drive a fastener into a scrap piece of wood to test depth.

Turning the dial in the direction shown in the image will result in the fastener driving deeper into the wood.

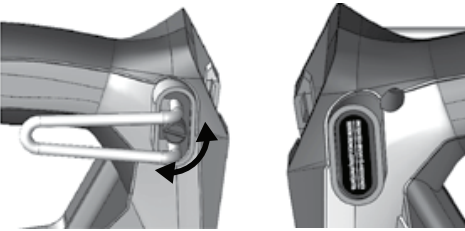

This tool is equipped with an adjustable 6 position belt hook for right and left handed operators. The hook will safely support the tool when hanging from joists and rafters.

Rotate the knurled knob to adjust opening or to switch from right to left side. Move black plastic cap to alternate side to complete assembly.



Whenever possible, hold the tool at a right angle to the work surface.

**Indicator LED ON**

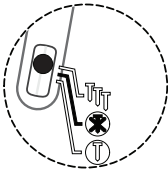

Always turn the tool off before storing. As an added protection feature, the tool will automatically turn off 34 minutes after the last activation.

If a nail jam occurs, the red light at the mode selector switch will flash red. The tool will attempt to recover after battery is removed and reset.

If the jam is severe, the driver blade will lock in place by design and the red flashing light will not clear. Contact an authorized service center.

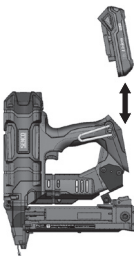

**Should a minor fastener jam occur:**

Turn the tool off by depressing the selector switch towards either mode symbol for approximately 1 second, then **remove battery**.

Insert battery and turn tool back on via mode selector switch. Tool will attempt to recover.

**Should a severe fastener jam occur:**

Turn the tool off by depressing the selector switch towards either mode symbol for approximately 1 second, then remove battery.

**Remove fasteners from magazine.**

Wear safety glasses when removing magazine.



Point nose of tool away from self and others.

Follow the unloading instructions to remove fasteners from magazine.

Remove the magazine (F-15XP) or keep the magazine open (F-16XP, F-LXP and F-18XP).

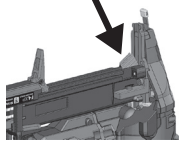

**⚠ Remember!** The Fusion tool is charged with compressed air in a factory sealed chamber.

Do not push on the driver with any force or use a hammer to strike the driver while it is visible.



Remove jammed fastener with a pliers or screwdriver.

Do not tamper with the drive assembly.

Re-attach the magazine or close the magazine.

Insert battery and turn tool back on via mode selector switch. Tool will attempt to recover.

If tool indicates a jam again via red light, return tool to authorized service center for evaluation

## TO CHARGE BATTERY

Place battery pack in charger.

Press down on battery pack.

When battery pack is connected, red light will turn on.

When your battery pack becomes 80% charged, the red light will stay on and the green light will flash.

When battery pack is fully charged, the red light will turn off and the green light will turn on.



Red and green light flashing indicates defective battery pack.

**Return battery pack to your nearest SENCO Authorized Service Center for inspection or replacement.**

Solid red indicates that the battery is charging.

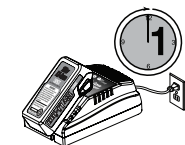

After normal usage, 45 minutes of charge time is required to be fully charged.

A maximum charge time of 1 hour is required to recharge a completely dis-charged battery pack.

Maintenance charge is indicated when the red light turns off while the green light flashes.

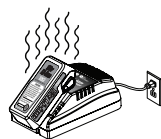

The battery pack will become slightly warm to the touch while charging. This is normal and does not indicate a problem.



Battery is constructed with 4 LED lights built into a panel on the battery pack. These 4 LEDs reveal the state of charge and indicate possible problems inside the battery pack.

### State of Charge:

Press raised green button on battery pack to check charge.

Red Flashing = 0–15% charge

Red On = 16–25% charge

Red and Yellow On = 26–50% charge

Red Yellow and Green On = 51–75% charge

All On = 76–100% charge





### Tips for maintaining Max life:

Charge the battery pack before it is completely discharged. Always stop tool operation and charge the battery when you notice less tool power.



Never recharge a fully charged battery. Overcharging shortens the battery service life.



Charge every 4-6 months.

## Battery Charger Label Reference

MODE	CHARGER LABEL ICON	BATTERY PACK INSERTED?	RED LIGHT/GREEN LIGHT
Standby	---	No	OFF / OFF
Evaluate	Evaluating / Hot	Yes	FLASH / OFF
Charging		Yes	ON / OFF
80% Charge		Yes	ON / FLASH
Fully Charged		Yes	OFF / ON
Maintenance	---	Yes	OFF / FLASH
Defective		Yes	FLASH / FLASH

## CHARGER SYMBOLS

SYMBOL	SIGNAL
	Double Insulated Class II
	CAUTION: High Voltage
	Time Delay Fuse

SYMBOL	SIGNAL
	Do not expose charger to water, rain or snow. Use indoors. This tool is only suitable for indoor use. Never expose tool to rain.
	Do not burn or incinerate battery packs. This may cause explosions.
	Do not immerse battery in water. Do not expose battery to rain.



### BATTERY DISPOSAL

- To preserve natural resources, please recycle or dispose of properly. This product contains Li-Ion. Local state or federal laws may prohibit disposal of Li-Ion batteries in ordinary trash.
- Consult your local waste authority for information regarding available recycling and/or disposal options.
- Do not dispose of electric tools together with household waste material! In observance of European Directive 2002/96/EC on waste electrical equipment and its implementation in accordance with national law, electric tools that have reached the end of their lives must be collected separately and returned to an environmentally compatible recycling facility.

### BATTERY TRANSPORT

- Ensure that battery contact terminals are protected and insulated to prevent short circuit.
- Ensure that battery pack is secured against movement within packaging.
- DO NOT transport batteries that are cracked or leak.

## Maintenance

Read section titled “Safety Warnings” before maintaining tool.

1. With battery removed, make daily inspection to ensure free movement of workpiece contact and trigger. Do not use tool if workpiece contact or trigger sticks or binds.
2. Lubrication of the feed system is not necessary. DO NOT OIL.
3. Wipe tool clean daily and inspect for wear, especially the workpiece contact. Replace as necessary.



**WARNING**

Repairs other than those described here should be performed only by trained, qualified personnel.

## Accessories

SENCO offers a full line of accessories for your SENCO tools, including:

- Battery
- Belt Hook
- Battery Charger
- Safety Glasses
- Case

For more information or a complete illustrated catalogue of SENCO accessories, ask your representative

# Fastener Specifications

## F-LXP

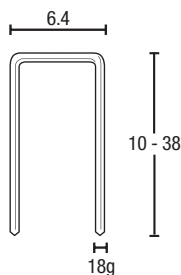

SENCO Fastener Code	A	
	IN.	MM
L06	3/8	9,5
L07	7/16	11
L08	1/2	13
L10	5/8	16
L11	3/4	19
L12	7/8	22
L13	1	25
L14	1-1/8	28,5
L15	1-1/4	32
L17	1-1/2	38

## Technical Specifications

	F-LXP
Voltage	18 volts Li-ion
Weight with Battery	3.0 kg
Height	31,5 cm
Length	26,4 cm
Width	9,5 cm
Recharge Time	45 minutes
Fastener Capacity	110
Fastener Range	9,5 mm - 38 mm
Collation Angle	0°

## Noise/Vibration Information

### Measured per EN60745-1: 2009 + A11: 2020 and EN60745-2-16: 2010

Sound power level (uncertainty K=3dBa) Lw	91.79 dB(A)
Sound pressure level (uncertainty K=3dBa) Lp	80.79 dB(A)
Total vibration level (emission ah)	3.03 m/s <sup>2</sup>
Total vibration level (uncertainty K)	1.5 m/s <sup>2</sup>

**Notes:** The declared vibration total has been measured in accordance with a standard test method and may be used for comparing one tool with another.

The declared vibration total value may also be used in a preliminary assessment of exposure.

**Warning:** The vibration emission during actual use of the power tool can differ from declared total value depending on the ways in which the tool is used.

Safety measures to protect the operator should be identified that are based on an estimation of exposure in the actual conditions of use (taking account of all parts of the operating cycle such as the times when the tool is switched off and when it is running idle in addition to the trigger time).

# Troubleshooting

Problem/Symptom	Probable Cause	Corrective Action
Pressing mode switch does not result in green light.	Check battery.	Remove and reattach.
	PCB is not energized.	Check that trigger and contact are free to move. Then choose mode selector.
	Electronic components damaged.	Return to an authorized service center.
Red light on.	Low battery.	Recharge or replace battery.
		Check battery connection at tool.
Red light flashes.	Fastener jam.	Remove battery and re-start.
		Tool will attempt to recover.
		Remove battery again.
		Check if nail is blocking next fastener.
		Inspect magazine for bent nail.
	Remove magazine and inspect guide body.	
	Tool does not function.	Return to service center for repair.
<b>Note:</b> If tool has jammed and the mechanism initiates an automatic recovery, the tool may make a series of clicks as it repositions the driver. This is normal.		
Tool will not start or runs slowly.	Battery is discharged or has dead cell.	Replace or recharge battery.
	Workpiece contact element is jammed.	Remove battery, then inspect tool to assure free movement of workpiece contact element.
	Drive piston has failed.	Return tool to authorized SENCO service representative.
	Workpiece contact element or trigger switches are damaged.	Return tool to authorized SENCO service representative.
Tool does not drive fastener to desired depth.	Improper depth-of drive setting.	Refer to operators manual for proper adjustment.
	Tool not pressed firmly against the workpiece.	Hold tool firmly in place when driving fastener.
	Drive application is too rigorous.	Refer to operators manual for appropriate applications.
	Pressure loss.	Return tool to authorized SENCO service representative.
Tool runs but will not drive fastener.	Battery is discharged or has a dead cell.	Recharge or replace with fresh battery.
	Nail jam in guidebody.	Refer to operators manual for jam-clearing instructions.
	Mechanism requires repair.	Return tool to authorized SENCO service representative.
	Tool is overheated.	Allow tool to cool and insert fresh battery.
	Driver tip not located above fastener.	Recharge battery and allow tool to automatically retract driver.

Problem/Symptom	Probable Cause	Corrective Action
Poor feed/ tool jamming.	Debris build-up in mechanism.	Clean tool, clean magazine or inspect feeder spring.
	Driver tip not located above fastener.	
Broken or worn driver.		Return tool to authorized SENCO service representative.
Tool does not fully return.	Weak battery.	Recharge battery and allow tool to automatically retract driver.

### Ensuring the long life of your Cordless Finish tool

Welcome to SENCO's family of products. SENCO brings 50 years of commitment to our customers and to power fastening systems. We are dedicated to making sure your tools are performing at their best, and we understand that ensuring the long life of your tools is important. Here are some operational and service tips.

- Start with fully charged batteries at the beginning of each work day.
- Set the depth of drive on your SENCO tool so fasteners are not over-driven.
- To maximize battery life, follow storage recommendations and charging recommendations in this manual.
- Keep your Cordless Nailer as clean and free of debris as possible.
- Service your SENCO tool periodically to insure your tool is productive and helping you earn money on the job. See the service guide below for recommended service intervals.

If your Cordless Nailer does require service, dedicated SENCO servicing dealers are available for you. For the location nearest you visit SENCO's website ([www.senco.eu](http://www.senco.eu)).

#### Recommended service includes

- Check Electrical System
- Check Feed System
- Check Drive Track
- Add Grease to Piston and Driver