

# metabo®

PROFESSIONAL POWER TOOL SOLUTIONS

**PowerMaxx BS 12**  
**PowerMaxx BS 12 Q**  
**PowerMaxx SB 12**



**CHI** 使用説明 5  
**ko** 지침 원본 9

**en** Original instructions 13

# SB 12

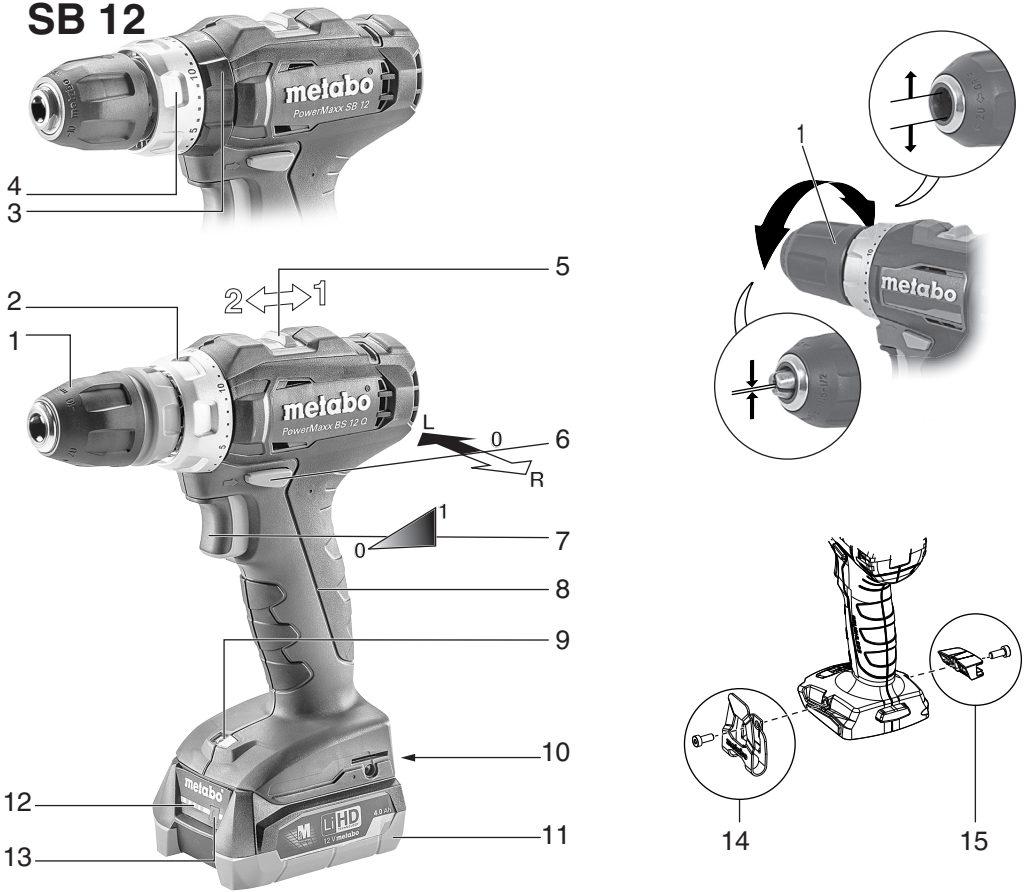

## PowerMaxx BS 12 Q

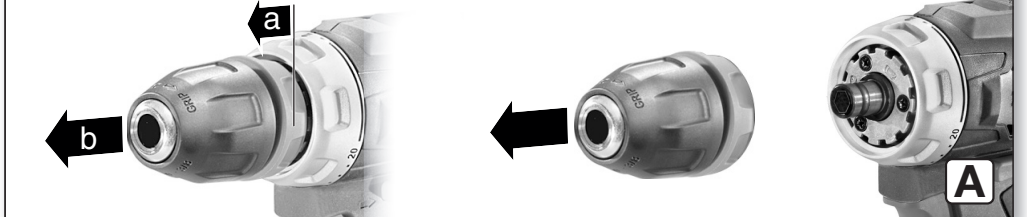



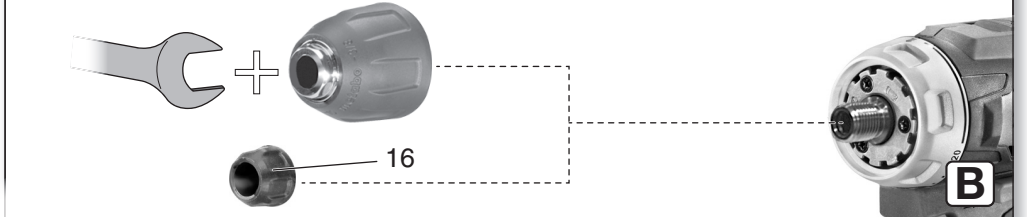

## PowerMaxx BS 12

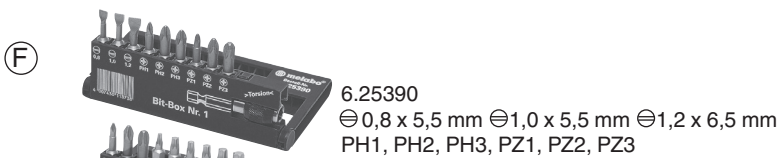
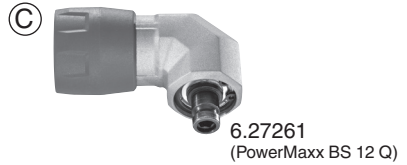
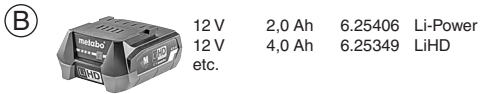
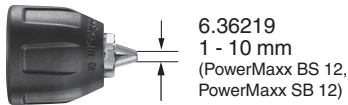
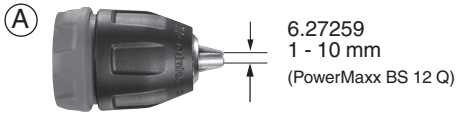
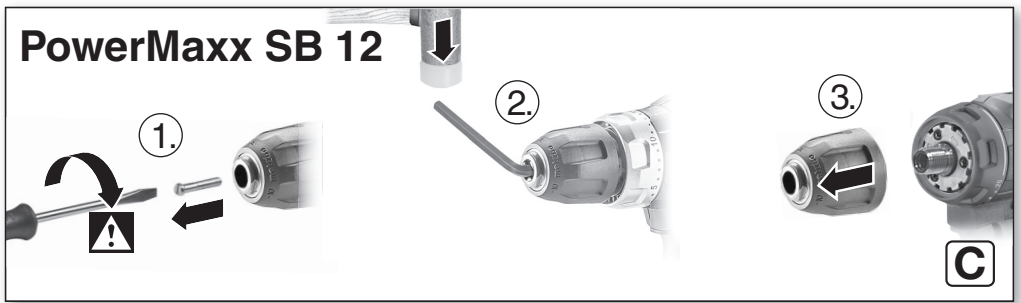

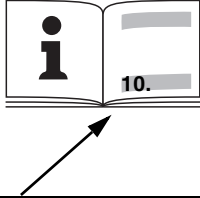
# PowerMaxx SB 12



			<b>PowerMaxx BS 12</b>	<b>PowerMaxx BS 12 Q</b>	<b>PowerMaxx SB 12</b>
<b>*1) Serial Number</b>			01036..	01037..	01076..
<b>U</b>	<b>V</b>		12		
<b>n<sub>0</sub></b>	<b>/min (rpm)</b>	1	0 - 360		
		2	0 - 1400		
<b>M<sub>A</sub></b>	<b>Nm (in-lbs)</b>	1	17 (150)		
<b>M<sub>B</sub></b>	<b>Nm (in-lbs)</b>	1	40 (354)		
<b>M<sub>C</sub></b>	<b>Nm (in-lbs)</b>	1 , 2	0,5 - 5,0 (4.4 - 44.3)		
<b>D<sub>1 max</sub></b> 	<b>mm (in)</b>	1	10 ( <sup>3</sup> / <sub>8</sub> )		
<b>D<sub>2 max</sub></b> 	<b>mm (in)</b>	1	18 ( <sup>23</sup> / <sub>32</sub> )		
<b>D<sub>3 max</sub></b> 	<b>mm (in)</b>	2	-	-	10 ( <sup>3</sup> / <sub>8</sub> )
<b>s</b>	<b>/min, bpm</b>	2	-	-	21000
<b>m</b>	<b>kg (lbs)</b>		1,0 (2.2)	1,1 (2.4)	1,1 (2.4)
<b>G</b>	-		1/2" - 20 UNF	-	1/2" - 20 UNF
<b>a<sub>h, ID</sub>/K<sub>h, ID</sub></b>	<b>m/s<sup>2</sup></b>		-	-	13 / 1,5
<b>a<sub>h, D</sub>/K<sub>h, D</sub></b>	<b>m/s<sup>2</sup></b>		3 / 1,5	2,5 / 1,5	
<b>a<sub>h, S</sub>/K<sub>h, S</sub></b>	<b>m/s<sup>2</sup></b>		2,5 / 1,5		
<b>L<sub>pA</sub>/K<sub>pA</sub></b>	<b>dB(A)</b>		64 / 3		85 / 3
<b>L<sub>WA</sub>/K<sub>WA</sub></b>	<b>dB(A)</b>		75 / 3		96 / 3



\*2) 2014/30/EU, 2006/42/EC, 2011/65/EU

\*3) EN 62841-1:2015, EN 62841-2-1:2018, EN 50581:2012

2018-11-12, Bernd Fleischmann  
 Direktor Produktentstehung & Qualität (Vice President Product Engineering & Quality)

\*4) Metabowerke GmbH - Metabo-Allee 1 - 72622 Nuertingen, Germany

*ppa. B.F.*

# Original instructions

## 1. Declaration of Conformity

We hereby declare that these cordless drills/screwdrivers and impact drills, identified by type and serial number \*1), meet all relevant requirements of directives \*2) and standards \*3). Technical documents for \*4) - see page 3.

## 2. Specified Conditions of Use

The drills and impact drills are suitable for drilling in metal, wood, plastic and similar materials, and also for screw driving and thread tapping.

The impact drills are also suited for drilling in masonry, brickwork and stone.

The user bears sole responsibility for any damage caused by inappropriate use.

Generally accepted accident prevention regulations and the enclosed safety information must be observed.

## 3. General Safety Information



For your own protection and for the protection of your power tool, pay attention to all parts of the text that are marked with this symbol!



**WARNING** – Read the operating instructions to reduce the risk of injury.



**WARNING** – Read all safety warnings, instructions, illustrations and specifications provided with this power tool. Failure to follow all instructions listed below may result in electric shock, fire and/or serious injury.

**Save all warnings and instructions for future reference.**

Always include these documents when passing on your power tool.

## 4. Special Safety Instructions

**Wear ear protectors when impact drilling (machines with the designation SB...).** Exposure to noise can cause hearing loss.

**Hold the power tool by insulated gripping surfaces, when performing an operation where the cutting accessory may contact hidden wiring.** Cutting accessory contacting a "live" wire may make exposed metal parts of the power tool "live" and could give the operator an electric shock.

**Safety instructions when using long drill bits:**

a) **Never operate at higher speed than the maximum speed rating of the drill bit.** At higher speeds, the bit is likely to bend if allowed to rotate freely without contacting the workpiece, resulting in personal injury.

b) **Always start drilling at low speed and with the bit tip in contact with the workpiece.** At higher speeds, the bit is likely to bend if allowed to

rotate freely without contacting the workpiece, resulting in personal injury.

c) **Apply pressure only in direct line with the bit and do not apply excessive pressure.** Bits can bend causing breakage and loss of control, resulting in personal injury.

Ensure that the spot where you wish to work is free of **power cables, gas lines or water pipes** (e.g. using a metal detector).



A slightly acidic, flammable fluid may leak from defective Li-ion battery packs!



If battery fluid leaks out and comes into contact with your skin, rinse immediately with plenty of water. If battery fluid leaks out and comes into contact with your eyes, wash them with clean water and seek medical attention immediately!



Protect battery packs from water and moisture!

Do not use faulty or deformed battery packs!



Do not expose battery packs to fire!

Do not open battery packs!

Do not touch or short circuit battery pack contacts!

If the machine is defective, remove the battery pack from the machine.

Remove the battery pack from the machine before any adjustment or maintenance is carried out.

Before fitting the battery pack, make sure that the machine is switched off.

Keep hands away from the rotating tool!

Remove chips and similar material only when the machine is at a standstill.

Secure the workpiece to prevent slipping or rotation (e.g. by securing with screw clamps).

LED light (9): do not observe the LED radiation directly with optical instruments.



CAUTION Do not stare at operating lamp.

**Reducing dust exposure:**



**WARNING** - Some dust created by power sanding, sawing, grinding, drilling, and other construction activities contains chemicals known to cause cancer, birth defects or other reproductive harm. Some examples of these chemicals are:

- Lead from lead-based paints,
- Crystalline silica from bricks and cement and other masonry products, and
- Arsenic and chromium from chemically treated lumber.

Your risk from these exposures varies, depending on how often you do this type of work. To reduce your exposure to these chemicals: work in a wellventilated area, and work with approved safety

equipment, such as those dust masks that are specially designed to filter out microscopic particles.

This also applies to dust from other materials such as some timber types (like oak or beech dust), metals, asbestos. Other known diseases are e.g. allergic reactions, respiratory diseases. Do not let dust enter the body.

Observe the relevant guidelines and national regulations for your material, staff, application and place of application (e.g. occupational health and safety regulations, disposal).

Collect the particles generated at the source, avoid deposits in the surrounding area.

Use suitable accessories for special work. In this way, fewer particles enter the environment in an uncontrolled manner.

Use a suitable extraction unit.

Reduce dust exposure with the following measures:

- do not direct the escaping particles and the exhaust air stream towards yourself or nearby persons or towards dust deposits,
- use an extraction unit and/or air purifiers,
- ensure good ventilation of the workplace and keep it clean using a vacuum cleaner. Sweeping or blowing stirs up dust.
- Vacuum or wash protective clothing. Do not blow, beat or brush protective gear.

### Transport of li-ion battery packs:

The shipping of li-ion battery pack is subject to laws related to the carriage of hazardous goods (UN 3480 and UN 3481). Inform yourself of the currently valid specifications when shipping li-ion battery packs. If necessary, consult your freight forwarder. Certified packaging is available from Metabo.

Only send the battery pack if the housing is intact and no fluid is leaking. Remove the battery pack from the machine for sending. Prevent the contacts from short-circuiting (e.g. by protecting them with adhesive tape).

## 5. Overview

See page 2.

- 1 Drill chuck / drill chuck sleeve\*
- 2 Adjusting sleeve (torque control, maximum torque) \*
- 3 Adjusting sleeve (screw driving, drilling, impact drilling) \*
- 4 Adjusting sleeve (torque limitation) \*
- 5 Slide-switch (1st/2nd gear)
- 6 Rotation selector switch (direction of rotation setting, transporting safety device)
- 7 Trigger switch
- 8 Handle
- 9 LED lights
- 10 Battery pack release button
- 11 Battery pack \*
- 12 Capacity and signal indicator \*
- 13 Capacity indicator button \*
- 14 Belt hook \*

15 Bit depot \*

16 Protective cap \*

\* equipment-specific

## 6. Use

### 6.1 The machine's multifunctional monitoring system

 If the machine switches off automatically, the machine electronics have activated automatic protection mode. A warning signal sounds (continuous beeping). The beeping stops after a maximum of 30 seconds or when the trigger switch (7) is released.

 In spite of this protective function, overloading is still possible with certain applications and can result in damage to the machine.

#### Causes and remedies:

1. **Battery pack almost flat** (the electronics prevent the battery pack from discharging totally and avoid irreparable damage).  
If one LED (12) is flashing, the battery pack is almost flat. If necessary, press the button (13) and check the LED lamps (12) to see the charge level. If the battery pack is almost flat, it must be recharged.
2. Long continuous overloading of the machine will activate the **temperature cut-out**.  
Leave the machine or battery pack to cool.  
Note: The machine will cool more quickly if you operate it at idling speed.
3. If the **current is too high** (for example, if the machine seizes continuously for long periods), the machine switches off.  
Switch off the machine at the trigger switch (7). Then continue working as normal. Try to prevent the machine from seizing.

### 6.2 Battery pack

Charge the battery pack before use.

Recharge the battery pack if performance diminishes.

Instructions on charging the battery pack can be found in the operating instructions of the Metabo charger.

In case of Li-Ion battery packs with capacity and signal display (12) (equipment-specific):

- Press the button (13), the LEDs indicate the charge level.
- The battery pack is almost flat and must be recharged if one LED is flashing.

#### Removing and inserting the battery pack

**Removal:** press the battery pack release button (10) and pull the battery pack (11) **forwards**.

**Insertion:** Slide the battery pack (11) in until it engages.

### 6.3 Setting the direction of rotation, engaging the transporting safety device (switch-on lock)

 Do not activate rotation selector switch (6) unless the motor has completely stopped! Actuate the rotation selector switch (direction of rotation setting, transporting safety device) (6).

See page 2:

- R = Clockwise setting
- L = Anti-clockwise setting
- 0 = middle position: transportation safety device (Switch-on lock) set

### 6.4 Selecting gear stage



- 1 1. gear (low speed, particularly high torque, preferable for screwing)
- 2 2. gear (high speed, preferable for drilling)

### 6.5 Set torque limitation, screw driving, drilling, impact drill

#### Machines with the designation BS...:

- 1...20 = Set **torque** (with torque limitation) by turning the sleeve (2) - intermediate settings are also possible.
-  = Set **drilling** by turning the sleeve (2) (max. torque, without torque limitation) To avoid overloading the motor, do not jam the spindle.

#### Machines with the designation SB...:

-  = Set **screwdriving** by turning the sleeve (3) AND set the **torque** (with torque limitation) by turning the sleeve (4) - intermediate settings are also possible.
-  = Set **drilling** by turning the sleeve (3) (max. torque, without torque limitation) To avoid overloading the motor, do not jam the spindle.
-  = Set **impact drilling** by turning the sleeve (3) (max. torque, without torque limitation) To avoid overloading the motor, do not jam the spindle.

### 6.6 Change accessory

#### Opening the drill chuck:

Turn the drill chuck sleeve (1) in clockwise direction.

#### Clamping the tool:

Open the drill chuck and insert the tool as far as possible. Turn the drill chuck sleeve (1) in anticlockwise direction until the tool is clamped securely. With a soft tool shank, retightening may be required after a short drilling period.

### 6.7 On/Off switch, modifying the speed

**Switching on, speed:** press the trigger switch (7). Press in the trigger switch to increase the rotational speed.

**Switching off:** release the trigger switch (7).

### 6.8 Drill chuck with "Quick" change system (for Powermaxx BS 12 Q)

**Removal:** See page 2, fig. A. Push the interlocking ring forward (a) and pull off the drill chuck (b).

**Mounting:** Push the interlock ring forward and move the chuck as far as the limit stop on the drill spindle.

### 6.9 Protective cap - drill chuck (for Powermaxx BS 12)

See page 2, fig. B.

When working without drill chuck, screw on the protective cap (16).

**Fit the drill chuck:** unscrew protective cap (16). Screw on the quick clamping drill chuck onto the spindle thread and tighten with an open-jawed spanner (**and remove in the same manner if needed**).

### 6.10 Drill chuck (for Powermaxx SB 12)

See page 2, fig. C.

Remove locking screw. Caution left-handed thread!

Clamp an Allen key in the chuck and strike lightly with a rubber hammer to loosen, then unscrew.

Employ the same procedure when attaching the chuck, except in reverse order.

## 7. Accessories

Use only original Metabo or CAS (Cordless Alliance System) battery packs and accessories.

See page 3, fig. D.

Use only accessories that fulfil the requirements and specifications listed in these operating instructions.

- A Quick-clamping chuck.
- B Battery packs with different capacities. Buy battery packs only with voltage suitable for your power tool.
- C Angle screwdriver attachment.
- D Battery charger
- E Bit holder with Quick replacement system
- F Bit box

For a complete range of accessories, see [www.metabo.com](http://www.metabo.com) or the catalogue.

## 8. Repairs

 Repairs to electrical tools must **ONLY** be carried out by qualified electricians!

Contact your local Metabo representative if you have Metabo power tools requiring repairs. See [www.metabo.com](http://www.metabo.com) for addresses.

You can download a list of spare parts from [www.metabo.com](http://www.metabo.com).

## 9. Environmental Protection

Observe the national regulations on environmentally compatible disposal and on the



## en ENGLISH

recycling of disused tools, packaging and accessories.

Battery packs may not be disposed of with regular waste. Return faulty or used battery packs to your Metabo dealer!

Do not allow battery packs to come into contact with water!



Protect the environment, and do not dispose of power tools and battery packs with household waste. Observe national regulations on separated collection and recycling of disused machines, packaging and accessories.

Discharge the battery pack in the power tool before disposal. Prevent the contacts from short-circuiting (e.g. by protecting them with adhesive tape).

- $a_{h, ID}$  = Vibration emission value (impact drilling in concrete)
- $a_{h, D}$  = Vibration emission value (Drilling in metal)
- $a_{h, S}$  = Vibration emission value (screwing without impact)
- $K_{h, ...}$  = Uncertainty (vibration)

Typical A-effective perceived sound levels:

- $L_{pa}$  = Sound-pressure level
  - $L_{WA}$  = Acoustic power level
  - $K_{pA}, K_{WA}$  = Uncertainty (noise level)
- During operation the noise level can exceed 80 dB(A).



**Wear ear protectors!**

## 10. Technical Specifications

Explanatory notes on the specifications on page 4.

Subject to change in accordance with technical progress.

$U$  = voltage  
(max. voltage = 12 V,  
nominal voltage = 10.8 V)

$n_0$  = No-load speed

Tightening torque for screwing:

$M_A$  = soft screwing application (wood)  
 $M_B$  = hard screwing application (metal)  
 $M_C$  = adjustable torque (with torque control)

Max. drill diameter:

$D_{1 \max}$  = in steel  
 $D_{2 \max}$  = in softwood  
 $D_{3 \max}$  = in masonry

$s$  = max. impact rate  
 $m$  = Weight (with the smallest battery pack)  
 $G$  = Spindle thread

Measured values determined in conformity with EN 62841.

Permitted ambient temperature during operation:  
-20 °C to 50 °C (limited performance with temperatures below 0 °C). Permitted ambient temperature for storage: 0 °C to 30 °C

== direct current

The technical specifications quoted are subject to tolerances (in compliance with relevant valid standards).



### Emission values

These values make it possible to assess the emissions from the power tool and to compare different power tools. The actual load may be higher or lower depending on operating conditions, the condition of the power tool or the accessories used. Please allow for breaks and periods when the load is lower for assessment purposes.

Arrange protective measures for the user, such as organisational measures based on the adjusted estimates.

Vibration total value (vector sum of three directions) determined in accordance with EN 62841: