

PowerMaxx SSE 12 BL

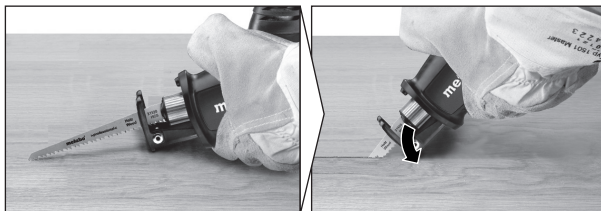

CHI 使用説明 5
ko 지침 원본 9

en Original instructions 13

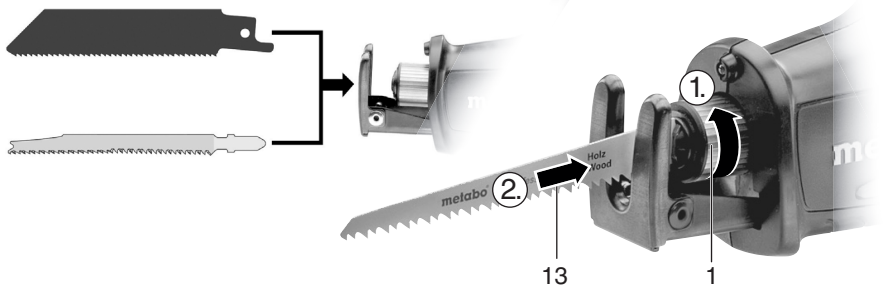
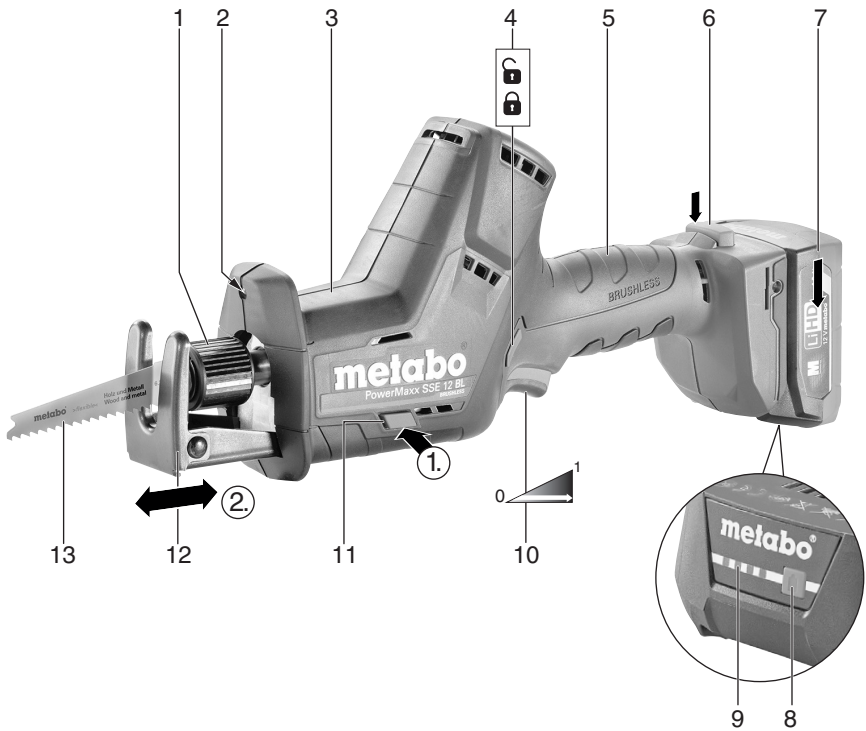



PowerMaxx SSE 12 BL

*1) Serial Number: 02322..

U	V	12
n₀	/min (spm)	0 - 3000
s	mm (in)	16 (⁵ / ₈)
T₁	mm (in)	80 (3 ¹ / ₈)
T₂	mm (in)	55 (2 ¹ / ₈)
m	kg (lbs)	1,6 (3.5)
a_{h, B}/K_{h, B}	m/s²	17 / 2,2
a_{h, WB}/K_{h, WB}	m/s²	14,5 / 1,5
L_{pA}/K_{pA}	dB(A)	78 / 3
L_{WA}/K_{WA}	dB(A)	89 / 3

CE *2) 2014/30/EU, 2006/42/EC, 2011/65/EU
 *3) EN 62841-1:2015, EN 62841-2-11:2016, EN 50581:2012

2019-04-17, Bernd Fleischmann
 Direktor Produktentstehung & Qualität (Vice President Product Engineering & Quality)
 *4) Metabowerke GmbH - Metabo-Allee 1 - 72622 Nuertingen, Germany

ppa. B.F.

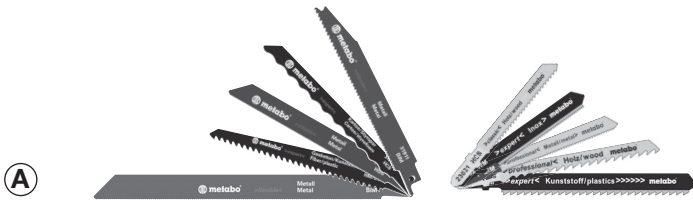

ASC 145,
SC 30,
etc.



12 V	2,0 Ah	6.25406	Li-Power
12 V	4,0 Ah	6.25349	LiHD
etc.			



6.23443

Original instructions

1. Declaration of Conformity

We declare under our sole responsibility: These cordless sabre saws, identified by type and serial number *1), comply with all relevant requirements of the directives *2) and standards *3). Technical file at *4) - see page 3.

2. Specified Use

The tool is suitable for sawing wood, metals, plastics or similar materials such as hard rubber, fibre glass, etc.

The user bears sole responsibility for any damage caused by improper use.

Generally accepted accident prevention regulations and the enclosed safety information must be observed.

3. General Safety Instructions



For your own protection and for the protection of your power tool, pay attention to all parts of the text that are marked with this symbol!



WARNING – Read the operating instructions to reduce the risk of injury.



WARNING – Read all safety warnings, instructions, illustrations and specifications provided with this power tool.

Failure to follow all instructions listed below may result in electric shock, fire and/or serious injury.

Save all warnings and instructions for future reference.

Always include these documents when passing on your power tool.

4. Special Safety Instructions

Hold the power tool by insulated gripping surfaces, when performing an operation where the cutting accessory may contact hidden wiring. Cutting accessory contacting a "live" wire may make exposed metal parts of the power tool "live" and could give the operator an electric shock.

Use clamps or another practical way to secure and support the workpiece to a stable platform. Holding the work by your hand or against the body leaves it unstable and may lead to loss of control.

When not in use, lock the machine with the switch-on lock (4) to prevent it from switching on inadvertently.

Remove the battery pack from the machine before any adjustments, conversions, servicing or cleaning are performed.

Before fitting the battery pack, make sure that the machine is switched off.

Always wear protective goggles, gloves, and sturdy shoes when working with this tool.

Ensure that the spot where you wish to work is free of **power cables, gas lines or water pipes** (e.g. using a metal detector).

When sawing water pipes, ensure that they do not contain any water.

Wear ear protectors when working for long periods of time. High noise levels over a prolonged period of time may affect your hearing.

Materials that generate dusts or vapours that may be harmful to health (e.g. asbestos) must not be processed.

Do not try to saw extremely small workpieces.

Only use sharp, undamaged saw blades. Do not use any cracked saw blades or blades that have changed their shape.

Only use the machine with the guide fitted. For sawing, the guide must make secure contact with the workpiece.

Always hold the machine with both hands using the handles provided, stand securely and concentrate.

Danger of injury due to the sharp saw blade.

Do not touch the moving saw blade! Remove chips and similar material only with the machine at standstill.

Do not reach under the workpiece while the machine is in operation.

Risk of crushing during operation! Keep your fingers away from the area of the saw blade tensioning device (1).

LED working light (2): Do not observe the LED radiation directly with optical instruments.



CAUTION Do not stare at operating lamp.



Protect battery packs from water and moisture!



Do not expose battery packs to naked flame!

Do not use faulty or deformed battery packs!

Do not open battery packs!

Do not touch or short-circuit battery packs!



Slightly acidic, flammable fluid may leak from defective li-ion battery packs!



If battery fluid leaks out and comes into contact with your skin, rinse immediately with plenty of water. If battery fluid leaks out and comes into contact with your eyes, wash them with clean water and seek medical attention immediately.

If the machine is defective, remove the battery pack from the machine.

Reducing dust exposure:



WARNING - Some dust created by power sanding, sawing, grinding, drilling, and other construction activities contains chemicals known to cause cancer, birth defects or other reproductive harm. Some examples of these chemicals are:

- Lead from lead-based paints,
- Crystalline silica from bricks and cement and other masonry products, and
- Arsenic and chromium from chemically treated lumber.

Your risk from these exposures varies, depending on how often you do this type of work. To reduce your exposure to these chemicals: work in a well ventilated area, and work with approved safety equipment, such as those dust masks that are specially designed to filter out microscopic particles.

This also applies to dust from other materials such as some timber types (like oak or beech dust), metals, asbestos. Other known diseases are e.g. allergic reactions, respiratory diseases. Do not let dust enter the body.

Observe the relevant guidelines and national regulations for your material, staff, application and place of application (e.g. occupational health and safety regulations, disposal).

Collect the particles generated at the source, avoid deposits in the surrounding area.

Use suitable accessories for special work. In this way, fewer particles enter the environment in an uncontrolled manner.

Use a suitable extraction unit.

Reduce dust exposure with the following measures:

- do not direct the escaping particles and the exhaust air stream at yourself or nearby persons or on dust deposits,
- use an extraction unit and/or air purifiers,
- ensure good ventilation of the workplace and keep clean using a vacuum cleaner. Sweeping or blowing stirs up dust.
- Vacuum or wash the protective clothing. Do not blow, beat or brush.

Transport of li-ion battery packs:

The shipping of li-ion battery pack is subject to laws related to the carriage of hazardous goods (UN 3480 and UN 3481). Inform yourself of the currently valid specifications when shipping li-ion battery packs. If necessary, consult your freight forwarder. Certified packaging is available from Metabo.

- Only send the battery pack if the housing is intact and no fluid is leaking. Remove the battery pack from the machine for sending. Prevent the contacts from short-circuiting (e.g. by protecting them with adhesive tape).

5. Overview

See page 2.

- 1 Saw blade tensioning device for jigsaw and reciprocating saw blades
- 2 LED working light
- 3 Front handle

- 4 Switch-on lock: To lock the trigger (10) to prevent the tool from switching on inadvertently.
- 5 Rear handle
- 6 Battery pack release button
- 7 Battery pack *
- 8 Capacity indicator button *
- 9 Capacity and signal indicator *
- 10 Trigger
- 11 Button for setting the guide
- 12 Guide
- 13 Saw blade

* depending on equipment/not in scope of delivery

6. Use

6.1 The machine's multifunctional monitoring system



If the machine switches off automatically, the machine electronics have activated automatic protection mode.

Causes and remedies:

1. **Battery pack almost flat** (the electronics prevent the battery pack from discharging totally and avoid irreparable damage).
If the battery pack is almost flat, it must be recharged.
2. Long continuous overloading of the machine will activate the **temperature cut-out**.
Leave the machine or battery pack to cool.
Note: The machine will cool more quickly if you operate it at idling speed.
3. If the **current is too high** (for example, if the machine seizes continuously for long periods), the machine switches off.
Switch off the machine at the trigger (10). Then continue working as normal. Try to prevent the machine from seizing.

6.2 Battery pack

Charge the battery pack (7) before use.

Recharge the battery pack if performance diminishes.

Instructions on charging the battery pack can be found in the operating instructions of the Metabo charger.

In case of Li-Ion battery packs with capacity and signal display (9) (equipment-specific):

- Press the button (8), the LEDs indicate the charge level.
- The battery pack is almost flat and must be recharged if one LED is flashing.

6.3 Removing and inserting the battery pack

To remove the battery pack: Press the battery pack release button (6) and remove the battery (7) pack.

To fit the battery pack: Slide in the battery pack (7) until it engages .

6.4 Fitting and removing the saw blade

 Before carrying out any work: Remove the battery pack.

 Do not touch the saw blade immediately following operation of the tool, as it can be extremely hot and can lead to skin burns.

 Use jigsaw saw blades as a general rule.

1. Turn the clamping sleeve (1) in the direction of the arrow and hold it.
2. Insert the saw blade (13) as far as the limit stop or remove it.
3. Release the clamping sleeve (1) (the clamping sleeve rotates back to its original position).
4. Check that the saw blade is securely seated.

Note when using **jig saw blades:** Both sabre saw and jig saw blades can be used. Use sabre saw blades as a general rule. When inserting jig saw blades, ensure that the jig saw blade is inserted in a vertical position as far as the limit stop. Slowly turn the clamping sleeve (1) back to its original position and ensure that the jig saw blade is fitting into the recess.

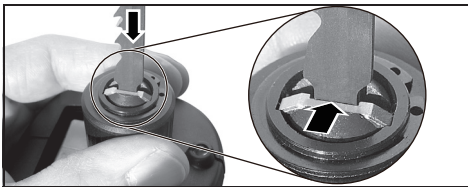

Note: Should it occur that a saw blade has broken off and it cannot be removed by hand from the saw blade quick-clamping device, turn the clamping sleeve (1) in the direction of the arrow and hold it. Engage the tip of a saw blade in the broken section and pull it out. A fine-toothed metal saw blade is best suited for this task.

6.5 Setting the guide

The cutting depth can be limited by shifting the guide (12) (e.g. when sawing in front of a wall).

Occasionally shift the guide (12) to achieve even wear of the saw blade.

1. Press the button (11) and shift the guide (12) to the desired position.
2. Release the button (11) and shift the guide until it engages.

 Check the guide (12) to ensure that it is securely fitted.

7. Use

7.1 Switching on and off, stroke rate, switch-on lock (4):

 Trigger (10) locked.

 Trigger (10) unlocked.

Switching on, speed: Press the trigger (10). The stroke rate can be changed by pressing in the trigger.

Switching off: Release the trigger (10).

7.2 Working instructions

Sawing:

Use a saw blade geared to the material to be sawn.

Press the machine with the guide (12) against the workpiece. Switch on the machine, and only then guide the saw blade against the workpiece.

Do not make contact with any objects or with the ground with the moving saw blade (risk of recoil or of breaking the saw blade).

Adapt the stroke rate to the material to be sawn.

Avoid excessive pressure on the saw blade (particularly in the case of long saw blades).

If the saw blade jams, turn the machine off immediately. Widen the sawn gap slightly with a suitable tool and take out the machine.

After completing the sawing cut, switch off the machine and only take it out of the sawn gap to place it down once the saw blade has come to a standstill (danger of recoil).

Lock the machine with the switch-on lock (4) to prevent it from switching on inadvertently.

Plunge cuts:

Plunge cuts may only be made in soft materials such as wood or plastic. Only use short saw blades.

Hold the machine with both hands at the intended handles, take a secure stance and concentrate on the work.

See illustration, page 3: The machine is pressed with the edge of the guide (12) against the workpiece. The saw blade does not make contact with the workpiece. Switch on machine. The corner of the guide serves as a pivot point around which the machine is slowly aligned, whereby the saw blade cuts into the workpiece.

8. Servicing

On a regular basis, use compressed air to blow out the machine through the motor ventilation slots.

Clean regularly: Press button (11) and remove guide (12). Hold the device downwards in a vertical position without the saw blade and, using your hand, lightly tap on the machine. The accumulated dust falls out. Do not oil or grease.

9. Accessories

Use only original Metabo or CAS (Cordless Alliance System) battery packs and accessories. See page 4.

Use only accessories which fulfil the requirements and specifications listed in these operating instructions.

- A Comprehensive range of saw blades for a wide variety of materials and use cases
- B Battery charger
- C Battery packs
- D Lubricating stick for cooling the saw blades when sawing metal

For a complete range of accessories, see www.metabo.com or the catalogue.

10. Repairs

 Repairs to electrical tools must be carried out by qualified electricians ONLY!

If you have Metabo electrical tools that require repairs, please contact your Metabo service centre. For addresses see www.metabo.com.

You can download spare parts lists from www.metabo.com.

11. Environmental Protection

Observe national regulations on environmentally compatible disposal and on the recycling of disused machines, packaging and accessories.

Battery packs must not be disposed of with regular waste. Return faulty or used battery packs to your Metabo dealer!

Do not allow battery packs to come into contact with water!

 Only for EU countries: Never dispose of power tools in your household waste! In accordance with European Guideline 2012/ 19/EU on used electronic and electric equipment and its implementation in national legal systems, used power tools must be collected separately and handed in for environmentally compatible recycling. Before disposal, discharge the battery pack in the power tool. Prevent the contacts from short-circuiting (e. g. by protecting them with adhesive tape).

12. Technical Specifications

Explanatory notes on the specifications on page 3.

Changes due to technological progress reserved.

- U = voltage
(max. voltage = 12 V,
nominal voltage = 10.8 V)
- n_0 = Stroke rate at idle speed
- s = Stroke length
- T_1 = max. cutting depth (wood)
- T_2 = max. cutting depth (metal profiles, metal pipes)
- m = Weight (with smallest battery pack)

Measured values determined in conformity with EN 62841.

Permitted ambient temperature during operation: -20 °C to 50 °C (limited performance with temperatures below 0 °C). Permitted ambient temperature for storage: 0 °C to 30 °C

== Direct current

The technical specifications quoted are subject to tolerances (in compliance with the relevant valid standards).



Emission values

Using these values, you can estimate the emissions from this power tool and compare these with the values emitted by other power tools. The actual values may be higher or lower, depending on the particular application and the condition of the tool or power tool. In estimating the values, you should also include work breaks and periods of low use. Based on the estimated emission values, specify protective measures for the user - for example, any organisational steps that must be put in place.

Vibration total value (vector sum of three directions) determined in accordance with EN 62841:

$a_{h, B}$ = Vibration emission level
(Sawing chip board)

$a_{h, WB}$ = Vibration emission level (sawing wood)

$K_{h, \dots}$ = Uncertainty (vibration)

Typical A-effective perceived sound levels:

L_{pA} = Sound pressure level

L_{WA} = Acoustic power level

K_{pA}, K_{WA} = Uncertainty

During operation the noise level can exceed 80 dB(A).



Wear ear protectors!