

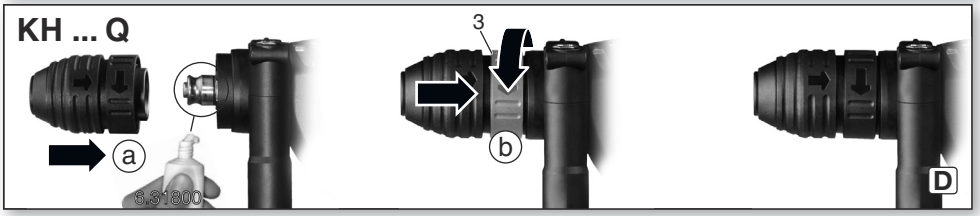

KH 18 LTX BL 24
KH 18 LTX BL 24 Q
KH 18 LTX BL 28 Q

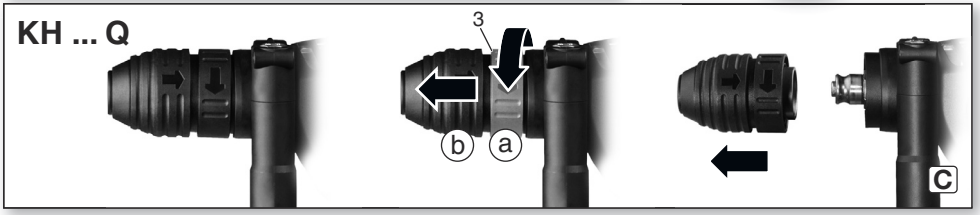

de	Originalbetriebsanleitung 4	fi	Alkuperäiset ohjeet 44
en	Original instructions 9	no	Original bruksanvisning 49
fr	Notice originale 14	da	Original brugsanvisning 54
nl	Oorspronkelijke gebruiksaanwijzing 19	pl	Instrukcja oryginalna 59
it	Istruzioni originali 24	el	Πρωτότυπο οδηγιών χρήσης 64
es	Manual original 29	hu	Eredeti használati utasítás 70
pt	Manual original 34	ru	Оригинальное руководство по эксплуатации 75
sv	Bruksanvisning i original 39	uk	Оригінальна інструкція з експлуатації 81

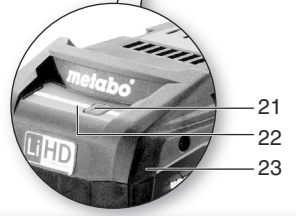
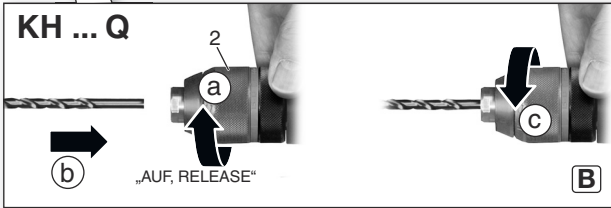
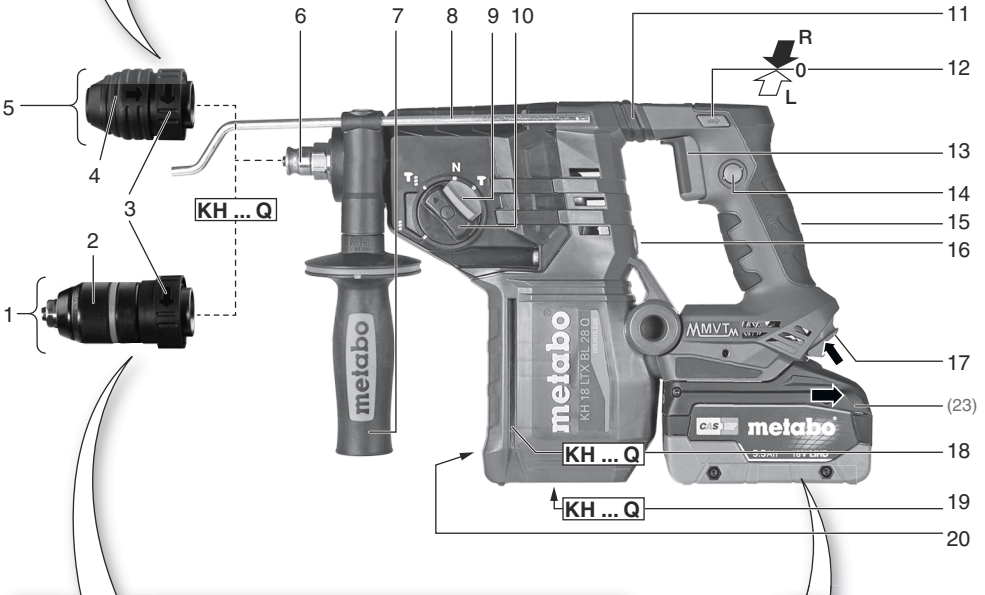
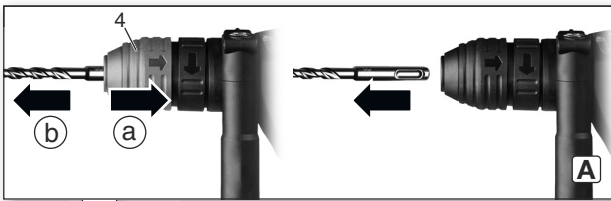

		KH 18 LTX BL 24 *1) Serial Number: 01713..	KH 18 LTX BL 24 Q *1) Serial Number: 01714..	KH 18 LTX BL 28 Q *1) Serial Number: 01715..
		SDS-plus	SDS-plus	SDS-plus
U	V	18	18	18
n₁	/min	0 - 1280	0 - 1280	0 - 1000
n₂	/min	1280	1280	1000
s_{max}	/min bpm	4750	4750	4470
W (EPTA 05/2009)	J	2,2	2,2	3,0
D₁	mm (in)	24 (1)	24 (1)	28 (1 ³ / ₃₂)
D₂	mm (in)	82 (3 ⁷ / ₃₂)	82 (3 ⁷ / ₃₂)	82 (3 ⁷ / ₃₂)
D₃	mm (in)	68 (2 ⁵ / ₈)	68 (2 ⁵ / ₈)	68 (2 ⁵ / ₈)
D₄	mm (in)	13 (1 ¹ / ₂)	13 (1 ¹ / ₂)	13 (1 ¹ / ₂)
D₅	mm (in)	30 (1 ¹ / ₈)	30 (1 ¹ / ₈)	30 (1 ¹ / ₈)
m	kg (lbs)	2,7 (5.95)	3,0 (6.61)	3,4 (7.5)
D	mm (in)	43 (1 ¹¹ / ₁₆)	50 (2 ¹ / ₁₆)	50 (2 ¹ / ₁₆)
a_{h,HD}/K_{h,HD}	m/s²	13,6 / 1,5	13,4 / 1,5	18,2 / 1,5
a_{h,Cheq}/K_{h,Cheq}	m/s²	9,2 / 1,5	9,1 / 1,5	13,4 / 1,8
L_{pA}/K_{pA}	dB (A)	90 / 3	90 / 3	92 / 3
L_{WA}/K_{WA}	dB (A)	101 / 3	101 / 3	103 / 3

 *2) 2014/30/EU, 2006/42/EC, 2011/65/EU
 *3) EN 62841-1:2015, EN IEC 62841-2-6:2020/A11:2020, EN IEC 63000:2018

2022-04-07, Bernd Fleischmann
 Direktor Produktentstehung & Qualität (Vice President Product Engineering & Quality)

*4) Metabowerke GmbH - Metabo-Allee 1 - 72622 Nuertingen, Germany

ppa. B.F.

Original instructions

1. Declaration of Conformity

We, being solely responsible: Hereby declare that these cordless hammers, identified by type and serial number *1), meet all relevant requirements of directives *2) and standards *3). Technical documents for *4) - see page 3.

For UK only:

UK We as manufacturer and authorized person to
CA compile the technical file, see *4) on page 3, hereby declare under sole responsibility that these drilling and chisel hammer, identified by type and serial number *1) on page 3, fulfill all relevant provisions of following UK Regulations S.I. 2016/1091, S.I. 2008/1597, S.I. 2012/3032 and Designated Standards EN 62841-1:2015, EN IEC 62841-2-6:2020/A11:2020, EN IEC 63000:2018

2. Specified Conditions of Use

The cordless hammers are suited, with appropriate accessories, for working with hammer drill bits and chisels in concrete, stone and similar materials and with core bits in tiles and similar, as well as drilling without impact in metal, wood, etc and for screwdriving.

The user bears sole responsibility for any damage caused by inappropriate use.

Generally accepted accident prevention regulations and the enclosed safety information must be observed.

3. General Safety Information



For your own protection and for the protection of your power tool, pay attention to all parts of the text that are marked with this symbol!



WARNING – Read the operating instructions to reduce the risk of injury.



WARNING – Read all safety warnings, instructions, illustrations and specifications provided with this power tool.

Failure to follow all instructions listed below may result in electric shock, fire and/or serious injury.

Save all warnings and instructions for future reference. Always include these documents when passing on your power tool.

4. Special Safety Instructions

4.1 Safety instructions for all operations

- Wear ear protectors.** Exposure to noise can cause hearing loss.
- Use auxiliary handle(s), if supplied with the tool.** Loss of control can cause personal injury.
- Hold the power tool by insulated gripping surfaces, when performing an operation where**

the cutting accessory or fasteners may contact hidden wiring. Cutting accessory contacting a "live" wire may make exposed metal parts of the power tool "live" and could give the operator an electric shock.

4.2 Safety instructions when using long drill bits with rotary hammers

- Always start drilling at low speed and with the bit tip in contact with the workpiece.** At higher speeds, the bit is likely to bend if allowed to rotate freely without contacting the workpiece, resulting in personal injury.
- Apply pressure only in direct line with the bit and do not apply excessive pressure.** Bits can bend, causing breakage or loss of control, resulting in personal injury.

4.3 Further Safety instructions

Always work with the additional handle correctly installed.

Always hold the machine with both hands at the intended handles, take a secure stance and concentrate on the work.

Wear personal protective equipment and always wear safety glasses. Protective equipment such as dust mask, non-skid safety shoes, protective gloves, hard hat, or hearing protection used for appropriate conditions will reduce personal injuries.

Ensure that the spot where you wish to work is free of **power cables, gas lines or water pipes** (e.g. using a metal detector).

Do not touch the rotating tool!

Secure the workpiece to prevent slipping or rotation (e.g. by securing with screw clamps).

Remove chips and similar material only with the machine at a standstill.

Caution must be exercised when driving screws into hard materials (driving screws with metric or imperial threads into steel)! The screw head may break or a high reverse torque may build up on the handle.

S-automatic safety clutch: If the tool jams or catches, the power supply to the motor is restricted. Due to the strong force which can arise, always hold the machine with both hands using the handles provided, stand securely and concentrate.

A damaged or cracked additional handle must be replaced. Never operate a machine with a defective additional handle.

LED light (20): do not observe the LED radiation directly with optical instruments.



CAUTION Do not stare at operating lamp.

Remove the battery pack from the machine before making any adjustments, changing tools, maintaining or cleaning.



Protect battery packs from water and moisture!

Do not expose battery packs to fire!



Do not use faulty or deformed battery packs!
Do not open battery packs!

Do not touch or short circuit battery pack contacts!

A slightly acidic, flammable fluid may leak from defective Li-Ion battery packs!



If battery fluid leaks out and comes into contact with your skin, rinse immediately with plenty of water. If battery fluid leaks out and comes into contact with your eyes, wash them with clean water and seek medical attention immediately!

If the machine is defective, remove the battery pack from the machine.

Transport of Li-Ion battery packs:

The shipping of Li-Ion battery packs is subject to laws related to the carriage of hazardous goods (UN 3480 and UN 3481). Inform yourself of the currently valid specifications when shipping Li-Ion battery packs. If necessary, consult your freight forwarder. Certified packaging is available from Metabo.

Only send the battery pack if the housing is intact and no fluid is leaking. Remove the battery pack from the machine for sending. Prevent the contacts from short-circuiting (e.g. by protecting them with adhesive tape).

Reducing dust exposure:

WARNING - Some dust created by power sanding, sawing, grinding, drilling, and other construction activities contains chemicals known to cause cancer, birth defects or other reproductive harm. Some examples of these chemicals are:

- Lead from lead-based paints,
- crystalline silica from bricks and cement and other masonry products, and
- arsenic and chromium from chemically treated lumber.

Your risk from these exposures varies, depending on how often you do this type of work. To reduce your exposure to these chemicals: work in a well-ventilated area, and work with approved safety equipment, such as those dust masks that are specially designed to filter out microscopic particles.

This also applies to dust from other materials, such as some timber types (like oak or beech dust), metals, asbestos. Other known diseases are e.g. allergic reactions, respiratory diseases. Do not let dust enter the body.

Observe the relevant guidelines and national regulations for your material, staff, application and place of application (e.g. occupational health and safety regulations, disposal).

Collect the particles generated at the source, avoid deposits in the surrounding area.

Use suitable accessories for special work. In this way, fewer particles enter the environment in an uncontrolled manner.

Use a suitable extraction unit.

Reduce dust exposure with the following measures:

- do not direct the escaping particles and the exhaust air stream towards yourself or nearby persons or towards dust deposits,
- use an extraction unit and/or an air purifier,
- ensure good ventilation of the workplace and keep it clean using a vacuum cleaner. Sweeping or blowing stirs up dust.
- Vacuum or wash protective clothing. Do not blow, beat or brush protective gear.

5. Overview

See page 2.

- 1 Keyless chuck *
- 2 Sleeve keyless chuck *
- 3 Chuck lock
- 4 Tool lock
- 5 SDS chuck
- 6 Spindle *
- 7 Additional handle
- 8 Depth stop
- 9 Lock
- 10 Switch button (for changing the operating mode)
- 11 Metabo VibraTech (MVT)
- 12 Rotation selector switch
- 13 Trigger switch
- 14 Lock button *
- 15 Handle
- 16 Button for reduced impact force (for working in soft material)*
- 17 Battery pack release button
- 18 Guide groove for the dust extraction ISA*
- 19 Rubber cover for dust protection of the power supply for the dust extraction ISA*
- 20 LED light to illuminate the workplace
- 21 Capacity indicator button *
- 22 Capacity and signal indicator *
- 23 Battery pack *

* depending on equipment/model/not included in scope of delivery

6. Initial Operation

6.1 Assembly of the additional handle

WARNING For safety reasons, always use the additional handle supplied.

Open the clamping ring by turning the side handle (7) anti-clockwise. Push the additional handle onto the collar of the machine. Insert the depth stop (8). Securely tighten the additional handle at the angle required for the application.

6.2 Battery pack

Charge the battery pack (23) before use.

Recharge the battery pack if performance diminishes.

Instructions on charging the battery pack can be found in the operating instructions of the Metabo charger.

Battery packs have a capacity and signal display (22) (depends on design variant):

- Press the button (21); the LEDs indicate the charge (22) level.
- The battery pack is almost empty and must be recharged if one LED is flashing.

6.3 Removing and inserting the battery pack

Removing:

Press the battery pack release (17) button and remove the battery pack (23).

Inserting:

Slide in the battery pack (23) until it engages.

7. Use

7.1 Depth Stop Setting

Loosen the additional handle (7). Set the depth stop (8) to the desired drilling depth and retighten additional handle (7).

7.2 Switching On and Off

Press the trigger switch (13) to switch on the machine.

The speed can be changed using the trigger switch.





To switch off release the trigger switch (13).



KH 18 LTX BL 28 Q: For continuous operation, the trigger button can be locked using the lock button (14). Press the trigger switch again to stop the machine.

 **In continuous operation, the machine continues running if it is forced out of your hands. Therefore, always hold the machine with both hands using the handles provided, stand securely and concentrate.**

7.3 Operating mode selection

Press the lock (9) and turn the thumbwheel (10).

-  Hammer drilling
(set only when using the hammer chuck (5))
-  Chiselling
(set only when using the hammer chuck (5))
-  Setting chisel position
Turn the chisel in the desired position. Then select "Chiselling" to secure the chisel and prevent it from twisting.
-  Drilling

 When a chisel is fitted, only operate the machine in the chiselling operating mode .

 Avoid levering with the machine when a chisel is fitted.

7.4 Setting impact force (KH 18 LTX BL 28 Q)

Press the button (16) to change the impact force (and the speed) (From 100% to 70%: Not while the motor is running).

Button (16) **illuminates**: reduced impact force, reduced speed (**approx. 70%**)

Button (16) **not illuminated**: maximum impact force, high speed (**100%**)

The correct setting is found by trial and error.

Example: if work is being completed on soft, brittle material or if you want to keep breakage to a low level, work at "reduced impact force".

Use the "maximum impact force" setting for working with harder materials.

7.5 Selection of direction of rotation

 Only activate the rotation selector switch (12) when the motor has completely stopped.

Select direction of rotation:

R = clockwise rotation (for drilling, hammer drilling, chiselling, drive in screws)

L = anti-clockwise rotation (for the removal of screws)

0 = Centre position: with the transporting safety device engaged (switch-on lock)

7.6 Drill chuck change (KH...Q)

 Ensure a clean spindle (6) when changing the chuck. Apply a light coating of grease to the spindle. (Special grease: Order No.: 6.31800)

 Only attach the Metabo chuck provided.

Removing the chuck:

See page 2, fig. C.

- Turn the chuck lock (3) in the direction of the arrow until the stop (a) and remove chuck (b).

Replacing the chuck:

See page 2, fig. D.

- Put the chuck onto the spindle (6) (a).
- Turn the chuck lock (3) in the direction of the arrow (b) until the chuck can be pushed completely onto the spindle and release the chuck lock.
- Check to see that the chuck is properly seated.

Note: To prevent the spindle from rotating when the chuck is being changed, put the switch button (10) to chiselling .

7.7 Tool change with SDS chuck

 Before fitting, clean tool shank and apply special grease (accessories order no. 6.31800)! Use only SDS-Plus tools.

Inserting tools:

- Turn tool and insert until it engages. The tool is automatically locked.

Remove the tool:

See page 2, fig. A.

- Pull tool lock (4) backwards in direction indicated by arrow (a) and remove tool (b).

7.8 Tool change keyless chuck (KH...Q)

Use the keyless chuck when drilling without impact into metal, wood etc. and for driving in screws.

Clamp tool (see p.2, fig. B):

Turn sleeve (2) in direction "OPEN, RELEASE" (a). Insert tool as deeply as possible (b) and turn sleeve in the opposite direction, until any perceptible mechanical resistance is overcome (c). **Caution! The tool is not yet clamped!**

Continue to turn vigorously (**you must hear a "click"**), until you cannot turn any further - **only now** is the tool **safely** clamped.

With a soft tool shank, retightening may be required after a short drilling period.

Notes: The rattling that might be heard after opening the chuck (depending on the function) can be eliminated by turning the sleeve into the other direction.

If the chuck is extremely tight: remove the battery pack from the machine. Hold the drill chuck at the drill chuck head using an open-end spanner and turn the sleeve (2) vigorously in the direction "OPEN, RELEASE".

7.9 Metabo VibraTech (MVT)

For reduced vibrations and less stress on the hands.

Always apply a moderate amount of pressure to the handle when pushing down the machine and do not force. Vibrations are reduced most effectively at the central position (11).

8. Maintenance and Cleaning

Vent slots:

The vent slots of the machine should be cleaned periodically.

Remove the **battery pack** periodically and wipe the contact area of the battery pack and machine with a dry cloth and remove drilling dust.

Always keep the **spindle (6)** clean and grease it a bit. (Special grease: Order No.: 6.31800)

Cleaning the keyless chuck (1):

After prolonged use, hold the chuck vertically with the opening facing downwards and fully open and close it several times. The dust collected falls from the opening. Regular use of cleaning spray on the jaws and jaw openings is recommended.

9. Troubleshooting (KH...Q)

Metabo **safety shutdown**: the machine has SHUT DOWN by itself. If the speed suddenly drops (for example, if the machine suddenly seizes or kickback occurs), the machine switches off. Switch off the machine at the trigger switch (13). Switch it on again and continue to work as normal. Try to prevent the machine from seizing.

10. Accessories

Only use original Metabo battery packs and Metabo accessories.

Use only accessories that fulfil the requirements and specifications listed in these operating instructions.

Fit accessories securely. If the machine is operated in a holder: secure the machine well. Loss of control can cause personal injury.

Chargers: ASC 145, etc.

Battery packs with different capacities. Buy battery packs only with voltage suitable for your power tool.

5.5 Ah (LiHD), order no.: 625368000 etc.

5.2 Ah (Li-Ion), order no.: 625028000 etc.

Integrated dust extraction system ISA:

for KH 18 LTX BL 24 Q: order no.: 631357xxx
for KH 18 LTX BL 28 Q: order no.: 631358xxx

For a complete range of accessories, see www.metabo.com or the catalogue.

11. Repairs

 Repairs to electrical tools must **ONLY** be carried out by qualified electricians!

Contact your local Metabo representative if you have Metabo power tools requiring repairs. For addresses see www.metabo.com.

You can download a list of spare parts from www.metabo.com.

12. Environmental Protection

Observe national regulations on environmentally compatible disposal and on the recycling of disused machines, packaging and accessories.

Packaging materials must be disposed of according to their labelling in accordance with municipal guidelines. Further information can be found at www.metabo.com in the "Service" section.

Battery packs may not be disposed of with regular waste. Return faulty or used battery packs to your Metabo dealer!

Do not allow battery packs to come into contact with water!

 Only for EU countries: never dispose of power tools in your household waste! According to European Directive 2012/19/EU on Waste from Electric and Electronic Equipment and implementation in national law, used power tools must be collected separately and recycled in an environmentally-friendly manner. Discharge the battery pack in the power tool before disposal. Prevent the contacts from short-circuiting (e.g. by protecting them with adhesive tape).

13. Technical Data

Explanatory notes on the specifications on page 3.
Subject to change in accordance with technical progress.

U	=	Voltage of battery pack
n_1	=	no-load speed
n_2	=	on-load speed
s_{max}	=	max. impact rate
W	=	max. single impact force
D_1	=	drill-Ø concrete with hammer drill bits
D_2	=	drill-Ø masonry with core bits
D_3	=	drill-Ø concrete with core bits
D_4	=	drill-Ø steel
D_5	=	drill-Ø soft wood
m	=	Weight with smallest battery pack
D	=	Collar diameter

Measured values determined in conformity with EN 62841.

Permitted ambient temperature during operation: -20 °C (-4°F) to 50 °C (120°F) (limited performance with temperatures below 0 °C (32°F)). Permitted ambient temperature for storage: 0 °C (32°F) to 30 °C (86°F).

== direct current

The technical specifications quoted are subject to tolerances (in compliance with relevant valid standards).



Emission values

These values make it possible to assess the emissions from the power tool and to compare different power tools. The actual load may be higher or lower depending on operating conditions, the condition of the power tool or the accessories used. Please allow for breaks and periods when the load is lower for assessment purposes. Arrange protective measures for the user, such as organisational measures based on the adjusted estimates.

Total vibration value (vector sum of three directions) determined in accordance with EN 62841:

$a_{h, HD}$ = Vibration emission value (hammer drilling into concrete)

$a_{h, Cheq}$ = Vibration emission value (chiselling)

$K_{h, HD/Cheq}$ = Uncertainty (vibration)

Typical A-effective perceived sound levels:

L_{pA} = sound-pressure level

L_{WA} = Acoustic power level

K_{pA}, K_{WA} = Uncertainty

During operation the noise level can exceed 80 dB(A).



Wear ear protectors!