

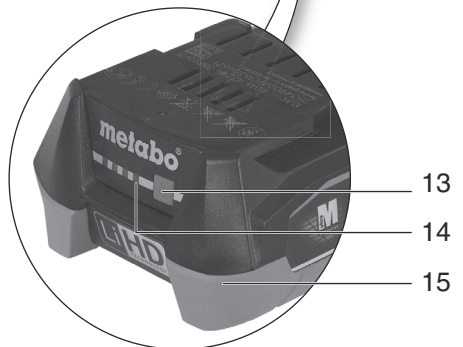

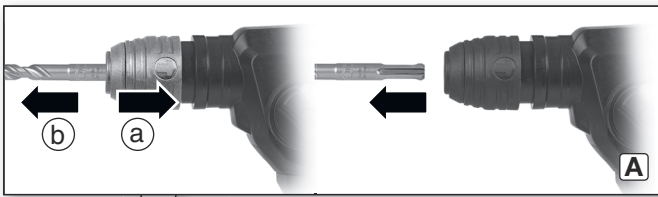







PowerMaxx BH 12 BL 16 BH 18 LTX BL 16

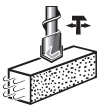

de	Originalbetriebsanleitung 4	fi	Alkuperäinen käyttöopas 36
en	Original instructions 8	no	Originalbruksanvisning 40
fr	Notice d'utilisation originale 12	da	Original brugsanvisning 44
nl	Oorspronkelijke gebruiksaanwijzing 16	pl	Instrukcja oryginalna 48
it	Istruzioni per l'uso originali 20	el	Πρωτότυπες οδηγίες λειτουργίας 52
es	Manual original 24	hu	Eredeti használati utasítás 57
pt	Manual original 28	ru	Оригинальное руководство по эксплуатации 61
sv	Bruksanvisning i original 32	uk	Оригінальна інструкція з експлуатації 66



			PowerMaxx BH 12 BL 16 *1) Serial Number: 00207..		BH 18 LTX BL 16 *1) Serial Number: 00324..	
	U	V	12		18	
	n₀	/min rpm	0 - 730			
	n₁	/min rpm	730			
	SDS-plus		✓			
	ø max.	mm (in)	16 (⁵ / ₈)			
	s max.	/min bpm	5250			
	W(EPTA (05/2009))	J	1,3			
	ø max.	mm (in)	68 (2 ⁵ / ₈)			
	ø max.	mm (in)	20 (²⁵ / ₃₂)			
	ø max.	mm (in)	13 (¹ / ₂)			
	m	kg (lbs)	1,7 (3.7)		1,9 (4.2)	
	D	mm (in)	43 (1 ¹¹ / ₁₆)			
	a_{h,HD}/K_{h,HD}	m/s²	14 / 1,5			
	L_{pA}/K_{pA}	dB(A)	92 / 3			
	L_{WA}/K_{WA}	dB(A)	100 / 3			

CE *2) 2014/30/EU, 2006/42/EC, 2011/65/EU

*3) EN 62841-1:2015+A11:2022, EN IEC 62841-2-6:2020/A11:2020, EN IEC 63000:2018

2022-09-02, Bernd Fleischmann
Direktor Produktentstehung & Qualität (Vice President Product Engineering & Quality)

*4) Metabowerke GmbH - Metabo-Allee 1 - 72622 Nuertingen, Germany

Original instructions

1. Declaration of Conformity

We declare and accept sole responsibility for ensuring: these cordless rotary hammers identified by their type and serial number *1) conform to all relevant provisions of the directives *2) and standards *3). Technical documents for *4) - see page 3.

For UK only:

UK We as manufacturer and authorized person to
CA compile the technical file, see *4) on page 3, hereby declare under sole responsibility that these cordless rotary hammers, identified by type and serial number *1) on page 3, fulfill all relevant provisions of following UK Regulations S.I. 2016/1091, S.I. 2008/1597, S.I. 2012/3032 and Designated Standards EN 62841-1:2015+A11:2022, EN IEC 62841-2-6:2020/A11:2020, EN IEC 63000:2018

2. Specified Use

With the appropriate accessories, the cordless rotary hammer is suitable for work with hammer drill bits in concrete, stone and similar materials and with core cutters in tiles and similar materials, as well as for non-impact drilling into metal, wood etc. and for driving screws.

The user bears sole responsibility for any damage caused by improper use.

Generally accepted accident prevention regulations and the enclosed safety information must be observed.

3. General safety instructions



For your own protection and for the protection of your power tool, pay attention to all parts of the text that are marked with this symbol!



WARNING – Read the operating instructions to reduce the risk of injury.



WARNING – Read all safety warnings, instructions, illustrations and specifications provided with this power tool. Failure to follow all instructions listed below may result in electric shock, fire and/or serious injury.

Save all warnings and instructions for future reference. Always include these documents when passing on your power tool.

4. Special Safety Instructions

4.1 Safety instructions for all operations

- a) **Wear ear protectors.** Exposure to noise can cause hearing loss.
- b) **Use auxiliary handle(s), if supplied with the tool.** Loss of control can cause personal injury.

c) **Hold the power tool by insulated gripping surfaces, when performing an operation where the cutting accessory or fasteners may contact hidden wiring.** Cutting accessory contacting a "live" wire may make exposed metal parts of the power tool "live" and could give the operator an electric shock.

4.2 Safety instructions when using long drill bits with rotary hammers

a) **Always start drilling at low speed and with the bit tip in contact with the workpiece.** At higher speeds, the bit is likely to bend if allowed to rotate freely without contacting the workpiece, resulting in personal injury.

b) **Apply pressure only in direct line with the bit and do not apply excessive pressure.** Bits can bend, causing breakage or loss of control, resulting in personal injury.

4.3 Further Safety instructions

Work only with the additional handle correctly installed.

Always hold the machine with both hands using the handles provided, stand securely and concentrate.

Wear personal protective equipment and always wear safety glasses. Protective equipment such as dust mask, non-skid safety shoes, protective gloves, hard hat, or hearing protection used for appropriate conditions will reduce personal injuries.

Ensure that the spot where you wish to work is free of **power cables, gas lines or water pipes** (e.g. by using a metal detector).

Do not touch the rotating tool!

Secure the workpiece against slipping, e.g. with the help of clamping devices.

Remove chips and similar material only when the machine is at a standstill.

Caution when carrying out hard screwdriving (driving of screws with either a metric or an imperial thread into steel)! The head of the screw may be ripped off or high restoring torques may occur on the handle.

High forces are released if the tool jams or catches. Always hold the machine with both hands by the intended handles, take a secure stance and concentrate on the work.

A damaged or cracked additional handle must be replaced. Never operate a machine with a defective additional handle.

LED light (12): do not observe the LED radiation directly with optical instruments.



CAUTION Do not stare at operating lamp.

Remove the battery pack from the machine before any adjustments, conversions or servicing are performed.



Protect battery packs from water and moisture!



Do not expose battery packs to naked flame!



Do not use faulty or deformed battery packs! Do not open battery packs!



Do not touch or short-circuit battery packs!



Slightly acidic, flammable fluid may leak from defective li-ion battery packs!



If battery fluid leaks out and comes into contact with your skin, rinse immediately with plenty of water. If battery fluid leaks out and comes into contact with your eyes, wash them with clean water and seek medical attention immediately.

If the machine is defective, remove the battery pack from the machine.

Transport of li-ion battery packs:

The shipping of li-ion battery pack is subject to laws related to the carriage of hazardous goods (UN 3480 and UN 3481). Inform yourself of the currently valid specifications when shipping li-ion battery packs. If necessary, consult your freight forwarder. Certified packaging is available from Metabo.

Only send the battery pack if the housing is intact and no fluid is leaking. Remove the battery pack from the machine for sending. Prevent the contacts from short-circuiting (e.g. by protecting them with adhesive tape).

Reducing dust exposure:



WARNING - Some dust created by power sanding, sawing, grinding, drilling, and other construction activities contains chemicals known to cause cancer, birth defects or other reproductive harm. Some examples of these chemicals are:

- Lead from lead-based paints,
- Crystalline silica from bricks and cement and other masonry products, and
- Arsenic and chromium from chemically treated lumber.

Your risk from these exposures varies, depending on how often you do this type of work. To reduce your exposure to these chemicals: work in a well ventilated area, and work with approved safety equipment, such as those dust masks that are specially designed to filter out microscopic particles.

This also applies to dust from other materials such as some timber types (like oak or beech dust), metals, asbestos. Other known diseases are e.g. allergic reactions, respiratory diseases. Do not let dust enter the body.

Observe the relevant guidelines and national regulations for your material, staff, application and place of application (e.g. occupational health and safety regulations, disposal).

Collect the particles generated at the source, avoid deposits in the surrounding area.

Use suitable accessories for special work. In this way, fewer particles enter the environment in an uncontrolled manner.

Use a suitable extraction unit.

Reduce dust exposure with the following measures:

- do not direct the escaping particles and the exhaust air stream at yourself or nearby persons or on dust deposits,
- use an extraction unit and/or air purifiers,
- ensure good ventilation of the workplace and keep clean using a vacuum cleaner. Sweeping or blowing stirs up dust.
- Vacuum or wash the protective clothing. Do not blow, beat or brush.

5. Overview

See page 2.

- 1 Tool lock
- 2 SDS chuck
- 3 Additional handle
- 4 Depth stop
- 5 Metabo VibraTech (MVT)
- 6 Rotation selector switch
- 7 Trigger switch
- 8 Lock
- 9 Switch button (for changing the operating mode)
- 10 Handle
- 11 Battery pack release button
- 12 LED light to illuminate the workplace
- 13 Capacity indicator button
- 14 Capacity and signal indicator
- 15 Battery pack *

* depending on model

6. Initial Operation

6.1 Assembly of the additional handle



For safety reasons, always use the additional handle supplied.

Open the clamping ring by turning the additional handle (3) anticlockwise. Push the additional handle onto the collar of the machine. Insert the depth stop (4). Securely tighten the additional handle at the angle required for the application.

6.2 Battery pack

Charge the battery pack (15) before use.

Recharge the battery pack if performance diminishes.

Instructions on charging the battery pack can be found in the operating instructions of the Metabo charger.

Battery packs have a capacity and signal display (14) (depends on design variant):

- Press the button (13); the LEDs indicate the charge level.
- The battery pack is almost flat and must be recharged if one LED is flashing.

6.3 Removing and inserting the battery pack

Removing:

Press the battery pack release (11) button and remove the battery pack (15).

Inserting:

Slide in the battery pack (15) until it engages.

7. Use

7.1 Depth Stop Setting

Loosen the additional handle (3). Set depth stop (4) to the desired drilling depth and retighten additional handle. (3)

7.2 Switching On and Off

Press the trigger switch (7) to switch on the machine. The speed can be changed by depressing the switch.

To switch off release the trigger switch (7).

7.3 Operating mode selection

Press (8) the lock and turn the thumbwheel (9).



Drilling



Hammer drilling

7.4 Selecting the direction of rotation

 Do not activate the direction switch (6) unless the motor has completely stopped.

Select direction of rotation:

R = clockwise rotation (for drilling, hammer drilling, drive in screws)

L = anti-clockwise rotation (for the removal of screws)

0 = Centre position: with the transporting safety device engaged (switch-on lock)

7.5 Tool change with SDS chuck

 Before fitting, clean tool shank and apply special grease (accessories order no. 6.31800)! Use only SDS-Plus tools.

Inserting tools:

- Turn tool and insert until it engages. The tool is locked automatically.

Removing the tool:

See page 2, fig. A.

- Pull tool lock (1) backwards in direction indicated by arrow (a) and remove tool (b).

7.6 Metabo VibraTech (MVT)

For reduced vibrations and less stress on the hands.

Always apply a moderate amount of pressure to the handle when pushing down the machine and do not force. Vibrations are reduced most effectively at the central position (5).

8. Maintenance, cleaning

- Ventilation slits:

Clean the ventilation slits on the machine occasionally.

- Remove the **battery pack** periodically and wipe the contact area of the battery pack and machine with a dry cloth and remove drilling dust.

9. Troubleshooting

Metabo S-automatic safety stop: The LED light (12) lights up and the machine SWITCHES OFF automatically. If the speed is too high (if the machine seizes suddenly), the machine switches off. Switch off the machine at the trigger switch (7). Switch it on again and continue to work as normal. Try to prevent the machine from seizing.

10. Accessories

Use only original Metabo or CAS (Cordless Alliance System) battery packs and accessories.

Use only accessories that fulfil the requirements and specifications listed in these operating instructions.

Fit accessories securely. If the machine is operated in a holder: secure the machine well. Loss of control can cause personal injury.

Batter chargers: ASC 55, ASC 30-36, etc.

Battery packs with different capacities. Only use battery packs with voltage suitable for your power tool.

Order no.:
625406000 12 V 2.0 Ah (LiPower)
625349000 12 V 4.0 Ah (LiHD)
etc.

625596000 18 V 2.0 Ah (LiPower)
625367000 18 V 4.0 Ah (LiHD)
etc.

For a complete range of accessories, see www.metabo.com or the catalogue.

11. Repairs

 Repairs to electrical tools must be carried out by qualified electricians ONLY!

If you have Metabo electrical tools that require repairs, please contact your Metabo service centre. For addresses see www.metabo.com.

You can download spare parts lists from www.metabo.com.

12. Environmental Protection

Observe national regulations on environmentally compatible disposal and on the recycling of disused machines, packaging and accessories.

Packaging materials must be disposed of according to their labelling in accordance with municipal guidelines. Further information can be found at www.metabo.com in the "Service" section.

Battery packs must not be disposed of with regular waste. Return faulty or used battery packs to your Metabo dealer!

Do not allow battery packs to come into contact with water!



Only for EU countries: Never dispose of power tools in your household waste! In accordance with European Guideline 2012/19/EU on used electronic and electric equipment and its implementation in national legal systems, used power tools must be collected separately and handed in for environmentally compatible recycling. Before disposal, discharge the battery pack in the power tool. Prevent the contacts from short-circuiting (e. g. by protecting them with adhesive tape).

13. Technical Specifications

Explanation of details on page 3. Subject to changes serving technical progress.

U	=	Voltage of battery pack
n_0	=	No-load speed
n_1	=	Load speed
dia_{max}	=	Maximum drill diameter
s_{max}	=	Maximum impact rate
W	=	Single impact force
m	=	Weight with smallest battery pack
D	=	D=Collar diameter

Measured values determined in conformity with EN 62841.

Permitted ambient temperature during operation: -20 °C (-4°F) to 50 °C (120°F) (limited performance with temperatures below 0 °C (32°F)). Permitted ambient temperature for storage: 0 °C (32°F) to 30 °C (86°F).

--- Direct current

The technical specifications quoted are subject to tolerances (in compliance with the relevant valid standards).



Emission values

Using these values, you can estimate the emissions from this power tool and compare these with the values emitted by other power tools. The actual values may be higher or lower, depending on the particular application and the condition of the tool or power tool. In estimating the values, you should also include work breaks and periods of low use. Based on the estimated emission values, specify protective measures for the user - for example, any organisational steps that must be put in place.

Vibration total value (vector sum of three directions) determined in accordance with EN 62841:

$a_{h,HD}$ = Vibration emission value (hammer drilling into concrete)

$K_{h,HD}$ = Uncertainty (vibration)

Typical A-effective perceived sound levels:

L_{pA} = Sound pressure level

L_{WA} = Acoustic power level

K_{pA}, K_{WA} = Uncertainty

During operation the noise level can exceed 80 dB(A).



Wear ear protectors!