

(D)	Originalbetriebsanleitung - Getriebe-Exzentrerschleifer	7
(GB)	Original operating manual - Gear-driven eccentric sander	11
(F)	Notice d'utilisation d'origine - Ponceuse roto-excentrique	15
(E)	Manual de instrucciones original - Lijadora excéntrica de engranaje	20
(I)	Istruzioni per l'uso originali - Levigatrice orbitale a motoriduttore	25
(NL)	Originele gebruiksaanwijzing - Roterend-excentrische schuurmachine	30
(S)	Originalbruksanvisning - Transmissions-excenterslip	34
(FIN)	Alkuperäiset käyttöohjeet - Vaihteella varustettu epäkeskohiomakone	38
(DK)	Original brugsanvisning - Excentersliber	42
(N)	Originalbruksanvisning -Slipe- og poleringsmaskin	46
(P)	Manual de instruções original - Lixadora excêntrica de engrenagem	50
(RUS)	Оригинал Руководства по эксплуатации - Эксцентриковая шлифмашина с редуктором	54
(CZ)	Originál návodu k obsluze -Excentrická bruska s převodovkou	59
(PL)	Oryginalna instrukcja eksploatacji -Przekładniowa szlifierka mimośrodowa	63

ROTEX RO 125 FEQ

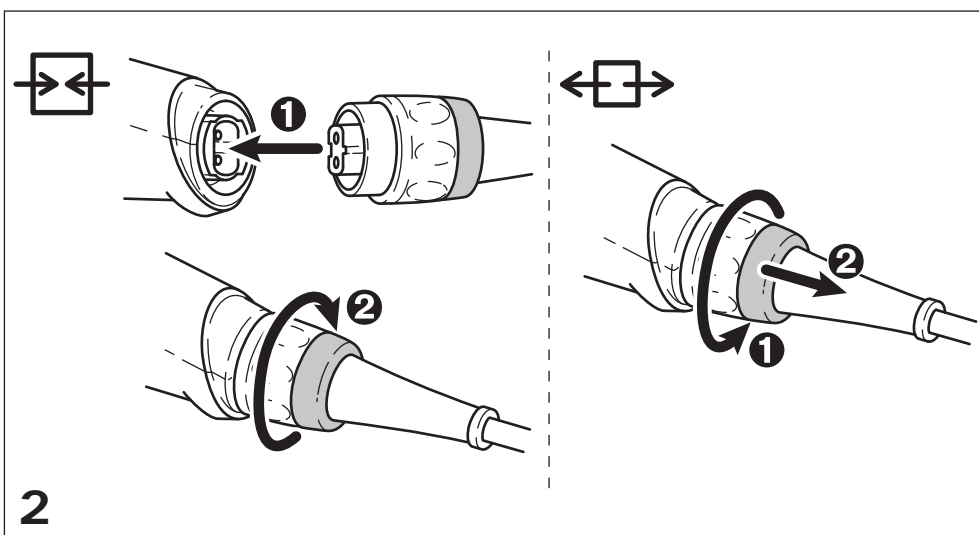

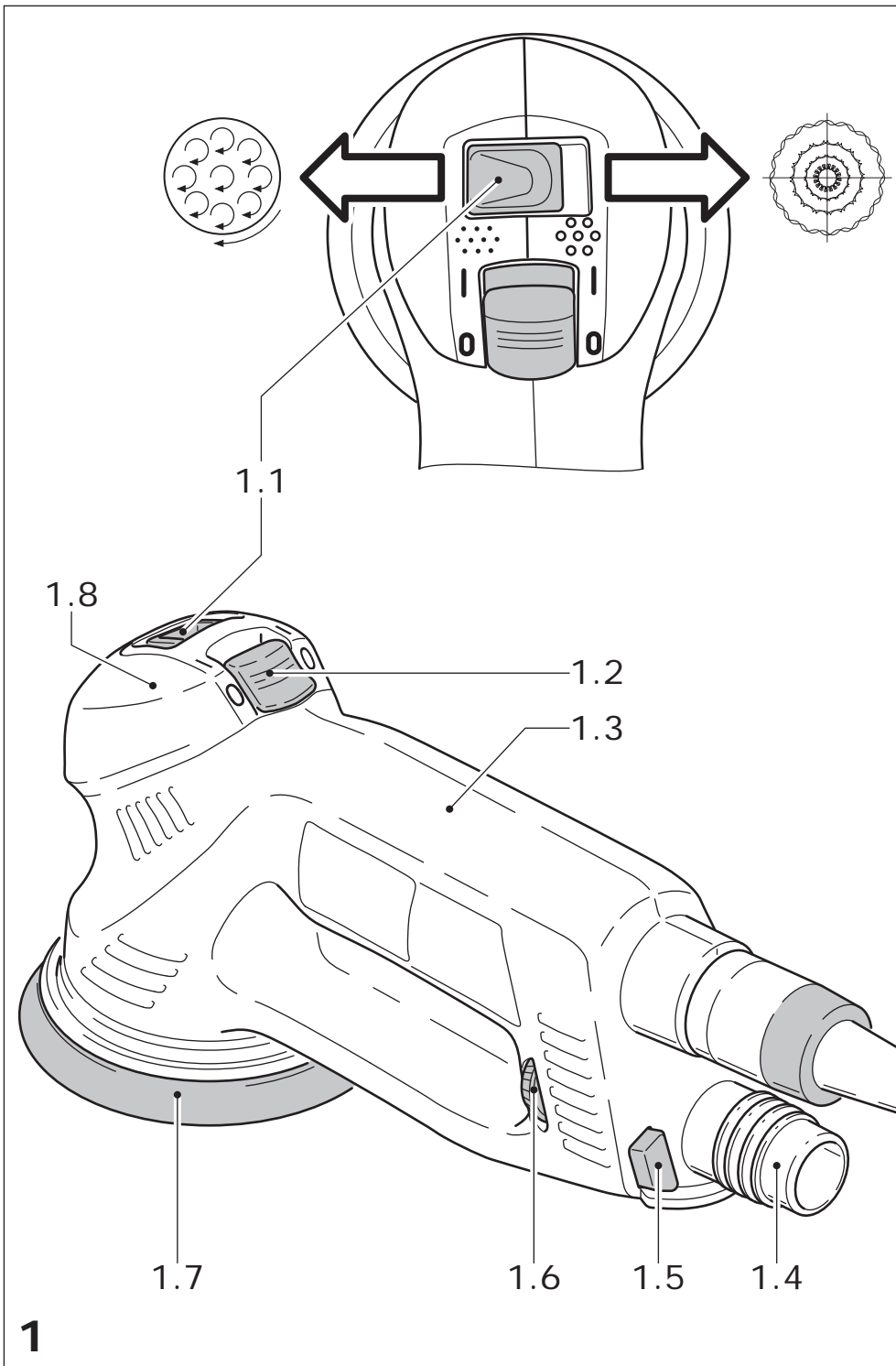

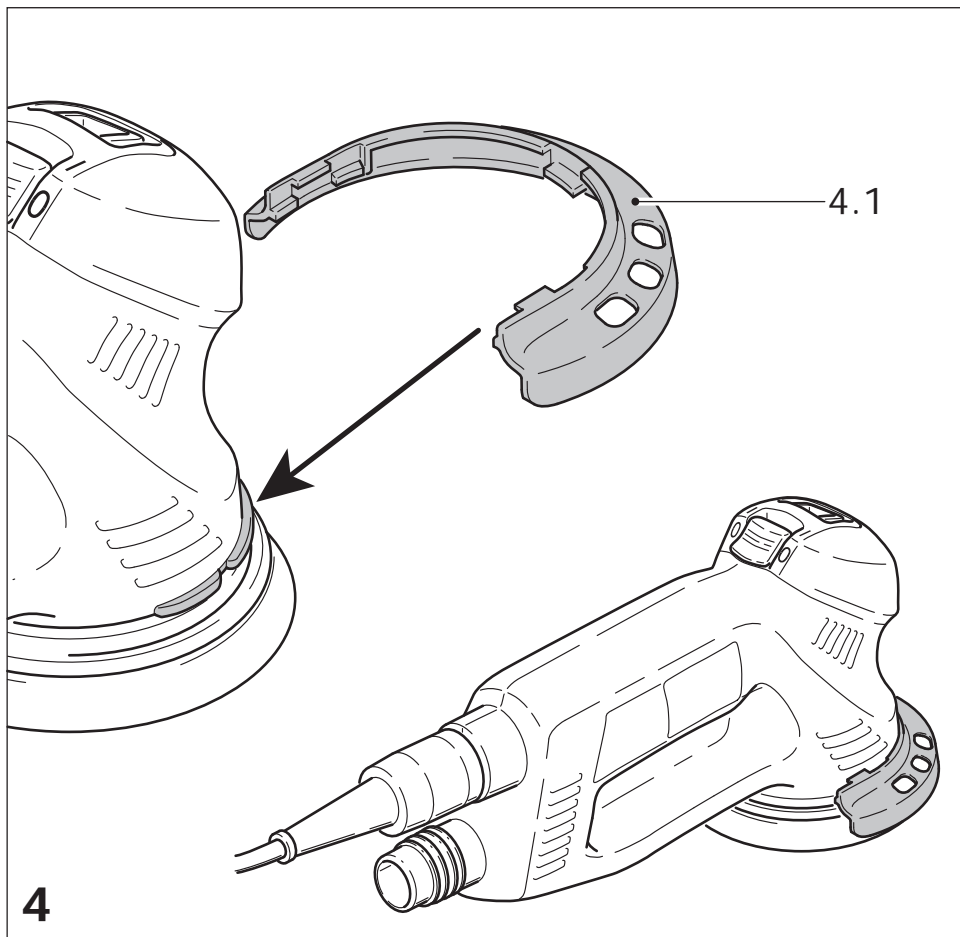
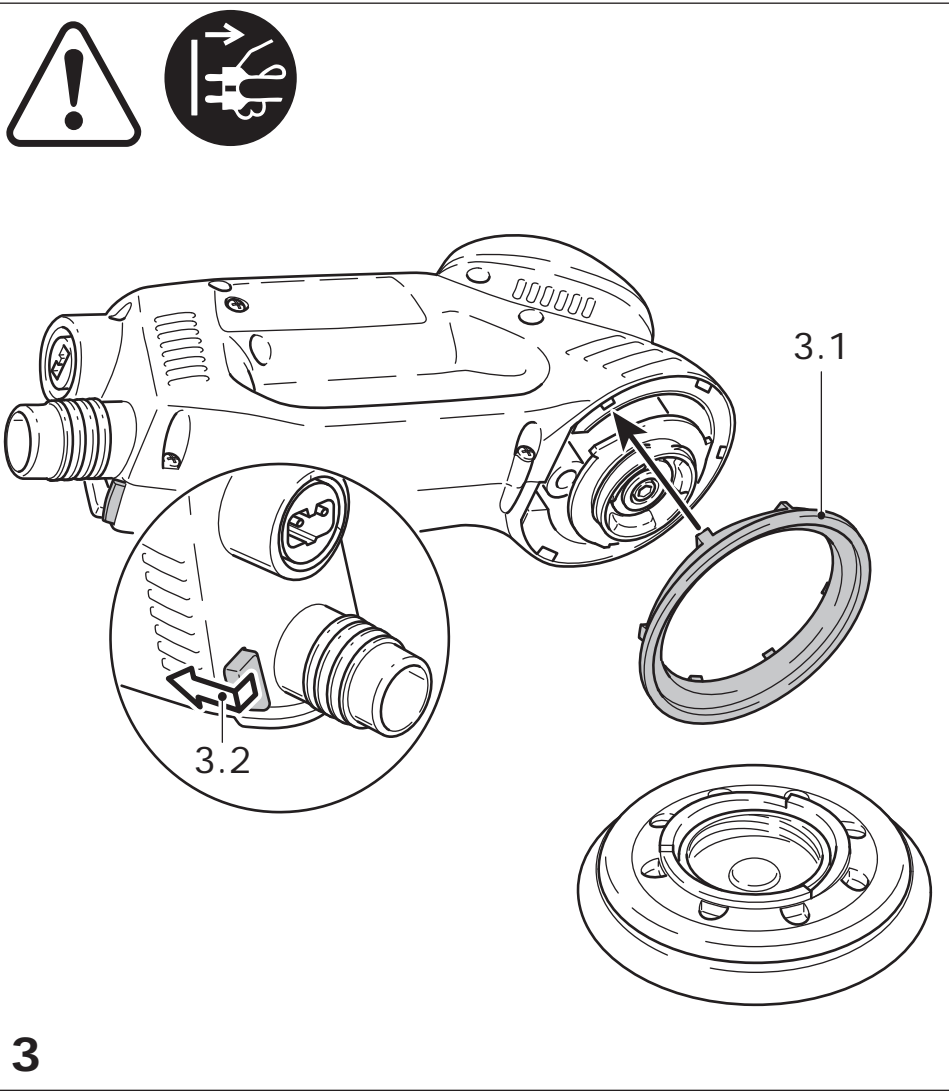

Getriebe-Exzentrerschleifer **Seriennummer ***
Gear-driven eccentric sander **Serial number ***
Ponceuse roto-excentrique **N° de série ***
(T-Nr.)

RO 125 FEQ

202872, 493660,
493772

de EG-Konformitätserklärung. Wir erklären in alleiniger Verantwortung, dass dieses Produkt allen einschlägigen Bestimmungen der folgenden Richtlinien einschließlich ihrer Änderungen entspricht und mit den folgenden Normen übereinstimmt:

en EC-Declaration of Conformity. We declare under our sole responsibility that this product is in conformity with all relevant provisions of the following directives including their amendments and complies with the following standards:

fr CE-Déclaration de conformité communautaire. Nous déclarons sous notre propre responsabilité que ce produit est conforme aux normes ou documents de normalisation suivants:

es CE-Declaración de conformidad. Declaramos bajo nuestra exclusiva responsabilidad que este producto corresponde a las siguientes normas o documentos normalizados:

it CE-Dichiarazione di conformità. Dichiariamo sotto la nostra esclusiva responsabilità che il presente prodotto è conforme alle norme e ai documenti normativi seguenti:

nl EG-conformiteitsverklaring. Wij verklaren op eigen verantwoordelijkheid dat dit produkt voldoet aan de volgende normen of normatieve documenten:

sv EG-konformitetsförklaring. Vi förklarar i eget ansvar, att denna produkt stämmer överens med följande normer och normativa dokument:

fi EY-standardinmukaisuusvakuutus. Vakuutamme yksinvastuullisina, etta tuote on seuraavien standardien ja normatiivisten ohjeiden mukainen:

da EF-konformitetserklæring Vi erklærer at have alene ansvaret for, at dette produkt er i overensstemmelse med de følgende normer eller normative dokumenter:

nb CE-Konformitetserklæring Vi erklærer på eget ansvar at dette produktet er i overensstemmelse med følgende normer eller normative dokumenter:

pt CE-Declaração de conformidade: Declaramos, sob a nossa exclusiva responsabilidade, que este produto corresponde às normas ou aos documentos normativos citados a seguir:

ru Декларация соответствия ЕС: Мы заявляем с исключительной ответственностью, что данный продукт соответствует следующим нормам или нормативным документам:

cs ES prohlášení o shodě: Prohlašujeme s veškerou odpovědností, že tento výrobek je ve shodě s následujícími normami nebo normativními dokumenty:

pl Deklaracja o zgodności z normami UE: Niniejszym oświadczamy na własną odpowiedzialność, że produkt ten spełnia następujące normy lub dokumenty normatywne:

2006/42/EG, 2014/30/EU, 2011/65/EU

EN 62841-1: 2015 + AC: 2015

EN 62841-2-4: 2014 + AC: 2015

EN 55014-1: 2017

EN 55014-2: 2015

EN 61000-3-2: 2014

EN 61000-3-3: 2013

EN 50581: 2012



Festool GmbH

Wertstr. 20, D-73240 Wendlingen
GERMANY

Wendlingen, 2018-12-04

Dr. Wolfgang Knorr
CTO

Ralf Brandt
Head of Standardization & Approbation

* im definierten Seriennummer-Bereich (S-Nr.) von 40000000 - 49999999

in the specified serial number range (S-Nr.) from 40000000 - 49999999









dans la plage de numéro de série (S-Nr.) de 40000000 - 49999999

Gear-drive eccentric sander

Technical data	RO 125 FEQ
Power	500 W
Speed	3000 - 6000 rpm
Sanding stroke	3.6 mm
Weight according to EPTA-Procedure 01:2014	1.9 kg

The specified illustrations can be found at the beginning of the operating instructions.

Graphical symbols

-  Caution. Danger!
-  Read the operating instructions/notes
-  Wear ear protection!
-  Wear protective goggles!
-  Wear a protective mask!
-  Disconnect from the power supply!
-  Do not throw in the household waste!
-  Safety class II

1 Intended use

As specified, the machines are designed for sanding and polishing wood, plastic, metal, composite materials, paint/varnish, filler and similar materials.

Materials containing asbestos must not be processed.

For reasons of electrical safety the machine must not be damp nor operated in a humid environment. The machine may only be used for dry sanding.

 The user is liable for damage and injury resulting from incorrect usage!

2 Before starting up, please observe the following

2.1 Safety instructions

 **WARNING!** Read all safety warnings, instructions, illustrations and specifications provided with this power tool. Failure to follow all instructions listed below may result in electric shock, fire and/or serious injury.

Save all warnings and instructions for future reference.

The term “power tool” in the warnings refers to your mains-operated (corded) power tool or battery-operated (cordless) power tool.

- Harmful/toxic dusts can occur during your work (e.g. lead-containing paint, some types of wood and metal). Contact with these dusts, especially inhaling them, can represent a hazard for operating personnel or persons in the vicinity. Comply with the safety regulations that apply in your country. Connect the electric power tool to a suitable extraction system.

 To protect your health, wear a P2 protective mask.

 Always wear protective goggles because of possible dangers when sanding.

- The manufacturer’s handling and processing instructions must be observed without fail if explosive or self-igniting dusts are likely to occur during sanding.

- **Prevent the penetration of liquid polish into the tool.** The penetration of liquid polish into the power tool increases the risk of an electric shock.

- **If the power tool is dropped or falls, check for damage to the machine and sanding pad. Remove the sanding pad for closer inspection. Repair damaged parts before using again.** Broken sanding pads and damaged machines can cause injuries and machine instability.

- **Only for AS/NZS:** The tool shall always be supplied via residual current device with a rated residual current of 30 mA or less.

2.2 Noise and vibration information

Typically, the noise levels that are determined in accordance with EN 62841 (see EC declaration of conformity) are as follows:

Sound pressure level	79 dB(A)
Sound-power level	90 dB(A)
Measuring uncertainty allowance	K = 3 dB

 Wear ear protection!

Vibration emission value a_h (vector sum for three directions) and uncertainty K measured in accordance with EN 62841 (see EU Declaration of Conformity):

Fine sanding	$a_h = 6.0 \text{ m/s}^2$
Coarse sanding	$a_h = 3.5 \text{ m/s}^2$
Polishing	$a_h = 6.0 \text{ m/s}^2$
	$K = 1.5 \text{ m/s}^2$

The specified emissions values (vibration, noise) – are used to compare machines.

- They are also used for making preliminary

estimates regarding vibration and noise loads during operation.

- They represent the primary applications of the power tool.



CAUTION

The noise emissions during actual use of the power tool can differ from the declared values depending on the ways in which the tool is used especially what kind of workpiece is processed.

- Identify safety measures to protect the operator that are based on an estimation of exposure in the actual conditions of use (taking account of all parts of the operating cycle such as the times when the tool is switched off and when it is running idle in addition to the trigger time).

3 Power supply and start-up



The mains voltage must correspond to the specification on the rating plate. To switch on the machine, press the switch (1.2) downwards and forwards until it locks into place. To switch off, press the switch downwards - this releases the switch locking and it goes into the OFF position.



Always switch the machine off before connecting or disconnecting the mains lead!



CAUTION

Heating of the Plug it connection if bayonet fitting is not completely locked

Risk of burns

- Before switching on the power tool, make sure that the bayonet fitting at the mains cable is closed fully and locked.

See Fig. 2 for connection and disconnection of the power cable.

4 Electronics



The machine has full-wave electronics with the following features:

Smooth start-up

The smooth start-up ensures the machine starts up jolt-free.

Speed adjustment

You can regulate the speed steplessly between 3000 and 6000 rpm using the adjusting wheel (1.6). This enables you to optimise the cutting speed to suit the material.

Constant speed

The pre-selected speed remains constant whether the machine is in operation or in neutral position.

Temperature control

If the motor temperature becomes too high, the power supply and speed are reduced. The tool then only runs with reduced power to enable rapid cooling by means of the motor ventilation. After cooling down, the tool accelerates again automatically.

5 Machine settings



Always remove the power supply plug from the socket before carrying out any work on the machine.

5.1 Sanding motion

You can use the switch (1.1) to set two different sanding motions.



The change can only be made when the sanding pad is stationary, as the switch is locked in place during operation for reasons of safety.

Rotex rotary motion (coarse sanding, polishing)

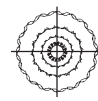

The Rotex rotary motion is a combination of rotary and eccentric motions. This position is selected for sanding with high output (coarse sanding) and polishing.

Slide the switch (1.1) into the right position.

Eccentric motion (fine sanding)



This position is selected for sanding with low output for a scratch-free surface (fine sanding).

Press the switch (1.1) downwards and push it into the left-hand position.

5.2 Sanding pad brake

The rubber collar (3.1) prevents the sanding pad from revving up to maximum speed in an uncontrolled manner during eccentric motion (fine sanding). Because the collar wears down in the course of time, it has to be replaced by a new one (order no. 453 388) as soon as there is any reduction in the braking effect.

5.3 Choice and installation of the sanding disks

Choice of sanding disk

The appliance can be fitted with three sanding disks of different hardness depending on the surface to be treated.

Hard: coarse sanding on surfaces, sanding at edges.

Soft: universal for coarse and fine sanding for flat and curved surfaces.

Super-soft: fine sanding on formed parts, curves, radii. Do not use on edges!

Assembly

The FastFix system enables tool-free replacement of the sanding pad:

- Set the switch (1.1) to the right, to the Rotex rotary motion
- Press spindle stop (1.5), direction of movement (3.2) first to the side, then forwards
- Turn the fitted sanding pad from the spindle (right-handed thread)
- Keep the spindle stop pressed and screw on the new sanding pad (in doing so, make sure that the rubber collar (3.1) is correctly fitted!)
- let go of the spindle stop

Actuate the spindle stop only when the drive spindle is stationary. Do not switch on the motor when the spindle stop is pressed in.

5.4 Attaching sanding material

The appropriate Stickfix sanding paper and Stickfix sanding felt can be fastened quickly and easily onto the Stickfix sanding base.

The self-adhesive sanding material is simply pressed onto the sanding base (1.7) and held safely in place by the Stickfix sanding base velcro surface. After use, the StickFix sandpaper is simply pulled off.

5.5 Securing polishing attachments

To prevent damage, PoliStick polishing attachments (sponges, felt, lambswool bonnets) may only be used on the special polishing pad that is fitted on the machine instead of a sanding pad. In the same way as the StickFix abrasives, the PoliStick polishing attachments are simply pressed onto the polishing pad and pulled off after use.

5.6 Dust extraction



Always connect the machine to a dust extractor.

You can connect a Festool extractor with an extractor hose diameter of 27 mm to the extractor connector (1.4).

5.7 Edge protector

The edge protector (4.1) prevents the sanding pad from touching the edge perpendicular to a surface (e.g. when sanding along a wall), thereby preventing the machine from rebounding.

Assembly

Slide the edge protector onto the machine until it latches into place (see Fig. 4).

6 Working with the machine



Always secure the workpiece in such a manner that it cannot move while being worked.

For safe guidance, hold the machine with one hand on the motor housing (1.3) and one hand on the gear head (1.8).

Never overload the tool by using too much pressure! The best sanding results are achieved when applying moderate pressure. The sanding performance and quality depend mainly on the choice of the right sanding material.

Tables A and B show the settings we recommend for different sanding and polishing work.

6.1 Metalworking



The following precautions are to be taken when processing metals for safety reasons:

- Pre-connect a residual current circuit-breaker.
- Connect the machine to a suitable dust extractor.
- Clean tool regularly of dust accumulations in the motor housing.



Wear protective goggles.

7 Accessories, tools



For your own safety, use only original Festool accessories and spare parts.

Festool offers the appropriate accessories, sanding and polishing attachments for every application.

The accessory and tool order number can be found in the Festool catalogue or on the Internet under "www.festool.com".

8 Maintenance and care



Always remove the power supply plug from the socket before carrying out any work on the machine.



All maintenance and repair work which requires the motor casing to be opened may only be carried out by an authorised service centre.



Customer service and repair. Only through manufacturer or service workshops: Please find the nearest address at: www.festool.com/Service



Use only original Festool spare parts! Order No. at: www.festool.com/Service

The cool air openings in the motor casing must always be kept clean and unobstructed to ensure air circulation.

The tool is fitted with special motor brushes with an automatic cut-out. When the brushes become worn the power supply is shut off automatically and the tool comes to a standstill.

10 General information

Imported into the UK by

Festool UK Ltd
1 Anglo Saxon Way
Bury St Edmunds
IP30 9XH
Great Britain

9 Disposal

Do not throw the power tool in your household waste! Dispose of the machine, accessories and packaging at an environmentally-responsible recycling centre! Observe the valid national regulations.

EU only: In accordance with European Directive on waste electrical and electronic equipment and implementation in national law, used electric power tools must be collected separately and handed in for environmentally friendly recycling.

Information on REACH: www.festool.com/reach













Table A: Sanding	Coarse sanding				Fine sanding			
								
 Paintwork, filler	X		5 - 6	soft	X		1 - 3	super soft
 Paintwork, paint	X		5 - 6	hard	X		3 - 6	hard
 Wood, veneered surface	X		5 - 6	hard	X		3 - 6	soft
 Plastics	X	X	4 - 6	soft	X		1 - 4	soft
 Steel, copper, aluminium	X		6	soft	X		3 - 6	soft

Table B: Polishing		Polishing	Sealing	High-gloss polishing
Paintwork		6	3	4 - 6
		Sponge, coarse/fine	Sponge, fine, honeycombed	Sheepskin
		Polishing paste	Hard wax	-
Plastics		6	3	6
		Felt, hard	Felt, soft	Sheepskin
		Polishing paste	Hard wax	-